

# THUNDER LASER SYSTEMS



## Thunder Bolt Pro Series Unified User's Manual

For Thunder Bolt Pro 22,32

Thunder Laser

[www.thunderlaser.com](http://www.thunderlaser.com)

[tech@thunderlaser.com](mailto:tech@thunderlaser.com)

**April 2024**

DONGGUAN THUNDER LASER EQUIPMENT CO.,LTD

Dongguan City, Guangdong Province, China

# Introduction

This manual has been designated as the thunder laser systems, laser cutting machine installation and user guide; The manual is divided into five chapters, including general information instructions, safety instructions, the key components of every laser cutting systems and the installation steps, operation instructions and maintenance instructions from THUNDERLASER Company.

First, it should be emphasized that the installation of each system must meet the requirements, and make it consistent with the installation requirements of THUNDERLASER. If not, the machine will not working properly, poor performance, life shortened, maintenance costs increased and even machine damage.

The note is for getting a specific requirement of system installation, and we hope every customer try to understand these notes before installation and usage, thus you can correctly install and use. If you meet any installation problems, you can contact our technical staff and customer service staff.

**Contents**

**CHAPTER 1. GENERAL ..... 5**

1.1 GENERAL INFORMATION ..... 5

1.2 DESIGNATED ..... 6

1.3 DISPOSAL REMARKS ..... 6

1.4 TECHNICAL DATA / DEVICE SPECIFICATION ..... 7

1.5 EC DECLARATION OF CONFORMITY ..... 9

1.6 MANUFACTURER'S LABEL ..... 10

**CHAPTER 2. SAFETY ..... 11**

2.1 GENERAL SAFETY INFORMATION ..... 11

2.2 LASER SAFETY INFORMATION ..... 12

2.3 SAFETY PRECAUTIONS WHEN OPERATING THE DEVICE ..... 13

2.4 WARNING AND INFORMATION LABELS ..... 14

**CHAPTER 3. PROCESS OF INSTALLING ..... 17**

3.1 UNPACKING ..... 17

3.2 LOCATION ..... 17

3.3 BEFORE INSTALLATION ..... 19

3.4 EXHAUST SYSTEM – REQUIREMENTS ..... 21

3.5 AIR SYSTEM – REQUIREMENTS ..... 21

3.6 COMPUTER – REQUIREMENTS ..... 22

3.7 CONNECTIONS ..... 23

3.7.1 *Connecting the Mains* ..... 23

3.7.2 *Connecting the Computer* ..... 24

**CHAPTER 4. OPERATION ..... 25**

4.1 MACHINE VIEW ..... 25

4.2 ON/OFF SWITCH ..... 28

4.3 HOW TO SETUP THE OEM SOFTWARE ..... 29

4.3.1 *Software installation* ..... 29

4.3.2 *Make connection between PC and machine* ..... 30

4.4 HOW TO USE THE DISPLAY ..... 34

4.4.1 *Function of the Buttons* ..... 34

4.4.2 *The main interface* ..... 35

4.5 HOW TO ADJUST FOCUS DISTANCE BY MANUAL OR AUTO ..... 39

4.6 HOW TO USE THE DIFFERENT OPTIONAL LENS(1.5", 2.5" & 4") ..... 41

4.7 HOW TO USE THE TL-TIMER ..... 43

4.8 HOW TO USE AIR-ASSIST CONTROL (IF EQUIPPED) ..... 45

4.9 HOW THE HEAT ALARM SYSTEM WORKS ..... 47

4.10 THE FIRST TIME RUNNING THE LASER ..... 49

4.11 WORKSTATION AREA INDICATION ..... 53

4.12 HOW TO USE THE CHUCK ROTARY AXIS ATTACHMENT ..... 54

4.13 FOR LASER ENGRAVING ..... 56

**CHAPTER 5. MAINTENANCE .....57**

5.1 CLEANING THE LASER MACHINE ..... 57

5.2 CLEANING THE OPTICAL PARTS ..... 58

    5.2.1 *Cleaning the Focus Lens* ..... 59

    5.2.2 *Cleaning the Mirrors* ..... 60

    5.2.3 *Cleaning Laser Combiner* ..... 62

5.3 CLEANING THE COOLING SYSTEM ..... 63

5.4 CHECK THE BEAM PATH ..... 65

5.5 MAINTAIN THE X/Y/Z RAILS ..... 66

5.6 MAINTENANCE PLAN ..... 67

## Chapter 1. General

### 1.1 General Information

Please read this documentation carefully before installation and operation.

**Injury, death, loss of property, fire, electric shock, malfunction, reduced performance & machine life, and critical failures can result from not reading, understanding, and following the Operation Manual!**

Operation of the system is permitted only with equipment and spare parts supplied or listed in the spare parts and consumables lists. The use of 3<sup>rd</sup> Party components may void the warranty.

Auxiliary equipment must be adjusted to the base machine (contact us for further info).

The following symbols are used throughout the Operation Manual:



**Caution:** Warnings to keep in mind when operating the laser.

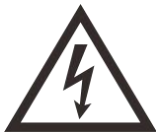

**High Voltage:** Care must be taken to prevent injury and/or death.

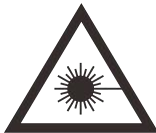

**Laser Radiation:** Pay attention to the dangers of the laser beam.



**Fire Hazard:** High potential for fire. NEVER RUN UNATTENDED!



**Tips:** Helpful notes or info that simplify the use or understanding.

## 1.2 Designated

The THUNDER LASER Thunder Bolt Pro SERIES is used for engraving and cutting of signs, stamps and suchlike.

A wide variety of materials such as rubber, acrylic, coated metal, tin, special steel, anodized aluminum, cork, cardboard, glass, leather, marble, several plastics and wood can be processed on the laser.



1. The engraving process must only be performed with a perfectly adjusted machine.
2. Use of the system in other areas is against the designated use. The manufacturer does not admit liability for damage to personal and/or equipment resulting from such use.
3. The system must only be operated, maintained and repaired, by personnel that are familiar with the designated field of use and the dangers of the machine!
4. Non-observance of the instructions for operation, maintenance and repair described in this Operation Manual excludes any liability of the manufacturer if a defect occurs.
5. Caution when processing conductive materials (carbon fibers), Conductive dust or particles in the ambient air might damage electrical components and lead to short circuits. Bear in mind that those defects are not warranted.

## 1.3 Disposal remarks



**Do not dispose the machine with domestic waste!**

Electronic devices have to be disposed according to the regional directives on electronic and electric waste disposal. In case of further questions, please ask your supplier. He might take care of proper disposal.

**1.4 Technical Data / Device Specification**

**Mechanics**

| System              | Thunder Bolt Pro 22     | Thunder Bolt Pro 32       |
|---------------------|-------------------------|---------------------------|
| Working Area        | 22"X 15"/559 x 381 mm   | 32"X 20"/813 X 508mm      |
| Table Size          | 25.9"X17.8"/660 x 453mm | 35.9"X 22.8"/914 X 580 mm |
| Z Axis Height       | 7.3"/185 mm             | 7.3"/185 mm               |
| Max Work Height     | 7.1"/182 mm             | 7.1"/182 mm               |
| Max Speed           | 2000mm/sec              |                           |
| Max work size       | Below 1000mm/s          | Below 1000mm/s            |
|                     | 20.8"x 15"/ 529 x381mm  | 30.8" x 20"/ 783 x508mm   |
|                     | Below 2000mm/s          | Below 2000mm/s            |
|                     | 18"x 15"/461 x381mm     | 28" x 20"/ 715 x508mm     |
| Motor               | High-speed Stepper      |                           |
| Working piece table | Honey comb table        |                           |
| Max table load      | 20kg                    | 20kg                      |
| Net Weight          | 190kg                   | 233kg                     |
| Standard Head       | 2.5" (63.5mm)           |                           |
| Lens Diameter       | 20mm                    |                           |
| Mirror Diameter     | 25mm                    |                           |
| Beam Comb. Dia      | 25mm                    |                           |

**Dimensions**

|           | Thunder Bolt Pro 22               | Thunder Bolt Pro 32                 |
|-----------|-----------------------------------|-------------------------------------|
| W x D x H | 41.3"X33.5"X40.2"/1050x852x1020mm | 51.3"x 38.6"x 41.2"/1304x980x1020mm |

**Max Part Size (W x L x H)**

|                    | Thunder Bolt Pro 22             | Thunder Bolt Pro 32                  |
|--------------------|---------------------------------|--------------------------------------|
| <b>Door Closed</b> | 23.6"X16.2"X 7.2"/600X413X183mm | 33.6"X 21.2"X 7.2"/854 x 540 x 183mm |

**Features**

[www.thunderlaser.com](http://www.thunderlaser.com)  
[tech@thunderlaser.com](mailto:tech@thunderlaser.com)  
 Tel: (86) 18103043363

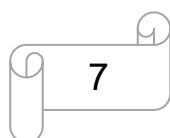

DONGGUAN THUNDER LASER EQUIPMENT CO., LTD  
 Room1101, Building 3, No.68, Xingzhou Road, Shatian Town,  
 Dongguan City, Guangdong Province, China

**Standard:**

100% faster motor system, 100% smoother guide Rail, 1000DPI RF metal laser source, Upper lower vent, Ten fold Open flap protection, Heat alarm detector, Dual air-assist control, Newly-designed focus lens and mirror holder, New housing design, Drawer for collecting small working pieces, Visible Red Dot Pointer, New Auto Focus, Smart board, Honey Comb Table, High quality power cable, Alarm lamp, Emergency Stop , 3D Engraving/Cutting, Breaker, Earth wiring, Rotary plug, Maintenance mode, Exhaust system.

**Optional:**

Rotary Attachment, High air compressor set (Includes water filter), 1.5", 2" & 4" Focus lenses

**Control System**

|                    |  |
|--------------------|--|
| Laser power        | Adjustable from 1 - 100% (typically 5-100%)              |
| Interface Hardware | USB: connect to PC and U-disk<br>Ethernet: connect to PC |
| Interface Software | LightBurn - RDWorksV8                                    |
| Operating Modes    | Optimized raster, vector, and combined mode              |
| Buffer Memory      | 1G standard  |

**Laser Equipment**

|                                |                                   |
|--------------------------------|-----------------------------------|
| Laser Type:                    | Sealed Radio frequency Laser Tube |
| Standard Laser Power:          | 30w or 55w                        |
| Wavelength:                    | 10.6µm                            |
| Red dot pointer:               | Laser Power< 1mW                  |
| Wavelength of Red dot pointer: | 630nm – 680nm                     |

**Cooling System**

|                         |            |
|-------------------------|------------|
| Machine Cooling System: | Air-Cooled |
| Tube Cooling System:    | Air-Cooled |

**Electricity, Power, Breaker**

|                             | 30W   | 55W                        |
|-----------------------------|---|----------------------------|
| Electricity Requirement     | 110V or 220 Volt AC, 50 or 60Hz, Single phase<br><b>Machine requires either 110V or 220V voltage(customized from factory);<br/>Support both 50Hz and 60Hz, single phase</b> |                            |
| Power consumption           | 644.7W, 110V<br>619.9W, 220V  | 1197W, 110V<br>1168W, 220V |
| Recommended circuit breaker | 20A, 110V<br>10A, 220V  | 20A, 110V<br>10A, 220V     |

**Ambient Conditions**

|                     |                                 |
|---------------------|---------------------------------|
| Ambient temperature | +15°C to +35°C / 59°F to 95°F   |
| Humidity            | 40% to max. 70%, not condensing |

**Laser Safety**

|              |                           |
|--------------|---------------------------|
| Laser Class  | Laser Class 2             |
| Laser Safety | CE compliant FDA approved |



**1.5 EC Declaration of Conformity**

**EC Declaration of Conformity**

**We**

Dongguan Thunder Laser Equipment Co., Ltd.

**Company's address**

Mintian, Shatian Dadao, Shatian Town, Dongguan, Guangdong, China

**declares that the product described is in conformity with**

**The Machinery Directive: 2006/42/EC and The EMC Directive: 2004/108/EC**

**Applicable Harmonized standards:**

EN ISO 11553-1:2008

EN 60204-1:2006+A1:2009

EN ISO 12100:2010

EN 60825-1:2014

EN ISO 13849-1:2008/AC:2009

EN ISO 13849-2:2012

**Product Name**

Laser System

**Product Model**

NOVA 51, NOVA 35, NOVA 53, NOVA 51, MINI 60,

Thunder Bolt, Thunder Bolt Plus, Thunder Bolt Pro 22, Thunder Bolt Pro 32

**Trade Mark**



**Name and address of the person authorized to compile the technical file**

Name: Tom Tang, Address: Banalog Farm, Banalog Terrace Hollybush Caerphilly, UK, NP12 0SF

**Authorized Representative:**

We guarantee that we will provide the authorized representative information before we export the machine to E.U.

**Responsible for making this declaration is the**

**Manufacturer**

**Authorized representative established within the EU**

2020-07-04

Tom Tang

Mintian, Shatian Dadao,  
Shatian Town,  
Dongguan, Guangdong,  
China

General Manager



**Issue date and Place**

**Name and position**

**Signature and company stamp**

## 1.6 Manufacturer's Label

The manufacturer's label is located on the back of the device (see Figure below).

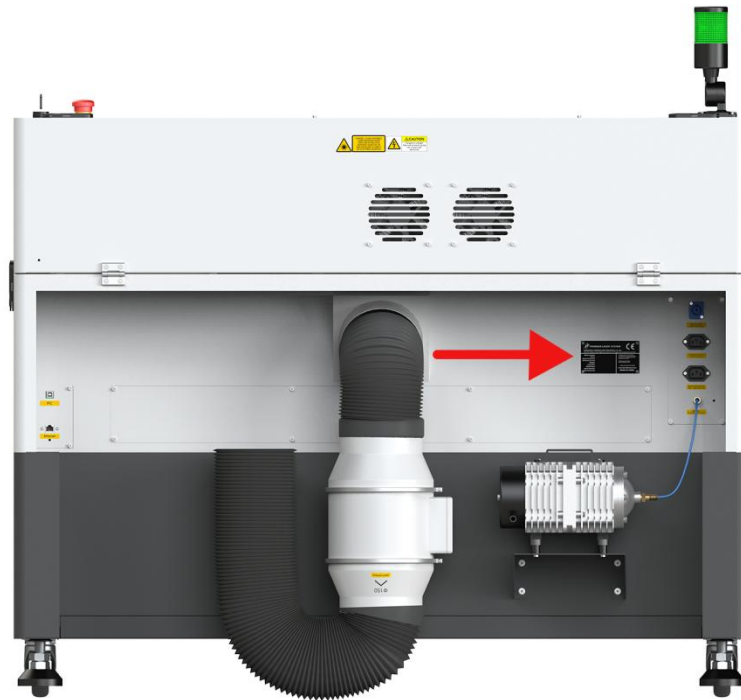

It is recommended to record all of the data so that you always have this handy. You will need to supply your Serial Number to our Support Team on occasion.



## Chapter 2. Safety

### 2.1 General Safety Information

All personnel involved in installation, set-up, operation maintenance and repair of the machine, must have read and understood the Operation Manual and in particular the "Safety" section. The user is recommended to generate company-internal instructions considering the professional qualifications of the personnel employed in each case, and the receipt of the instruction/Operation Manual or the participation at introduction/training should be acknowledged in writing in each case.

#### Safety-conscious of Working

The machine must only be operated by trained and authorized personnel.

The scopes of competence for the different activities in the scope of operating the machine must be clearly defined and observed, so that under the aspect of safety no unclear questions of competence occur. This applies in particular to activities on the electric equipment, which must only be performed by special experts.

For all activities concerning installation, set-up, start-up, operation, modifications of conditions and methods of operation, maintenance, inspection and repair, the switch-off procedures that may be provided in the Operation Manual must be observed.

#### Safety Information for the User and/or Operating Personnel



1. No working methods are permitted that affect the safety of the machine.
2. The operator must also ensure that no unauthorized persons work with the machine (e.g. by activating equipment without authorization).
3. It is the duty of the operator, to check the machine before start of work for externally visible damage and defects, and to immediately report changes that appear (including behavior during operation) that affect the safety.
4. The user must provide that the machine is only operated in perfect condition.
5. The user must guarantee the cleanness and accessibility at and around the machine by corresponding instructions and controls.
6. No safety components may be removed or disabled (again we emphasize the imminent dangers, for example severe burns, loss of eyesight, etc...). If the removal of safety components is required during repair and service, the replacement of the safety components must be performed immediately after completion of the service and repair activities.
7. Preparation, retooling, change of work piece, maintenance and repair activities **must only performed with equipment switched off** and by trained personnel.
8. **Any attempt to perform unauthorized modifications and changes to the machine can VOID THE WARRANTY.** This does not apply to preventative & general maintenance, adjustment and alignment, etc... that follow Thunder Laser's best practices.

## 2.2 Laser Safety Information



1. To assess the potential dangers laser systems pose, they are classified into 2 safety classes, Thunder Laser Thunder Bolt Pro series is a device of class 2. This is guaranteed by the protective housing and the safety installations.

Please note that improper and warranty operation of the device can override the status of Safety class 2 and can cause the emission of harmful radiation.

2. This laser engraving system contains a carbon dioxide (CO<sub>2</sub>) laser of class 4 that emits intensive and invisible laser radiation. Without safety precautions the direct radiation or even diffuse reflected radiation is dangerous!

3. Without safety precautions, the following risks exist with exposure to laser radiation:

Eyes: Burns to the cornea

Skin: Burns

Clothing: Danger of fire

4. Never try to modify or disassemble the laser and do not try to start up a system that had been modified or disassembled!

5. Dangerous radiation exposure can result from the use of operation or adjustment equipment other than that described here, and if different operational methods are performed.

## 2.3 Safety Precautions when Operating the Device

Your Thunder Laser Thunder Bolt Pro SERIES has an integrated safety system which immediately stops the job when the protection cover (Lid) is opened. An incomplete job will occur if the cover is opened during operation. Press the "PAUSE" button first if you want to interrupt an engraving process.

**Please remember the following safety precautions when working with this device:**



1. CO2 Fire extinguishers should be placed near laser. Always keep a properly maintained and inspected fire extinguisher on hand.
2. Do not store any flammable materials in the inside of the device. Particularly leftovers of produced materials have to be removed to prevent fire hazard.
3. Please maintain free airflow around this system at all times. Do not cover the machine while in operation.
4. Stay with the laser. Do not leave the laser unattended when it is working, small scraps can ignite and without supervision can destroy the machine if not checked.
5. Use Air Assist. Always use the system's Air Assist feature when vector cutting.



1. These lasers emit invisible radiation; safety glasses should be worn when maintaining these machines for your protection.
2. Adjustment of the beam path must be performed only by specially trained personnel. An improper setting can lead to uncontrolled emission of the laser radiation.



1. Do not disable limit switches or safety features as this can invalidate warranties and cause damage to you and the machine.
2. Before processing materials the user must verify whether harmful materials can be generated and whether the filter equipment of the exhaust system is suitable for the harmful materials. We emphasize that it is the responsibility of the user, to consider the national and regional threshold values for dust, fogs and gases when selecting the filters and the exhaust system. (The values for the maximum workplace concentration must not be exceeded.)
3. PVC (polyvinyl chloride) must under no circumstances be processed with the laser.

**2.4 Warning and Information Labels**



The warning and information labels in various locations if the machine should always be read carefully and understood. If labels are lost or damaged, they must be replaced immediately.



CLASSIFIED TO EN 60825-1:2014  
Safety of laser products - Part 1:  
Equipment classification and  
requirements  
Emitted wavelength(s):10.6µm  
Maximum output of laser radiation:55w

CAUTION-CLASS 2 LASER  
RADIATION WHEN OPEN  
DO NOT STARE INTO THE BEAM  
CLASS 2 LASER PRODUCT

DANGER - CLASS 4 INVISIBLE  
LASER RADIATION WHEN  
OPEN AND INTERLOCKS  
DEFEATED AVOID EYE OR  
SKIN EXPOSURE TO DIRECT  
OR SCATTERED RADIATION



**CAUTION**

Unplug before cleaning,  
maintenance and repair!



**WARNING**

TOXIC FUMES/PARTICLES  
MAY BE GENERATED BY  
THIS MACHINE



**CAUTION**

Wear eye protection  
during operation!



**CAUTION**

Read instruction manual  
before operation, cleaning  
and maintenance!

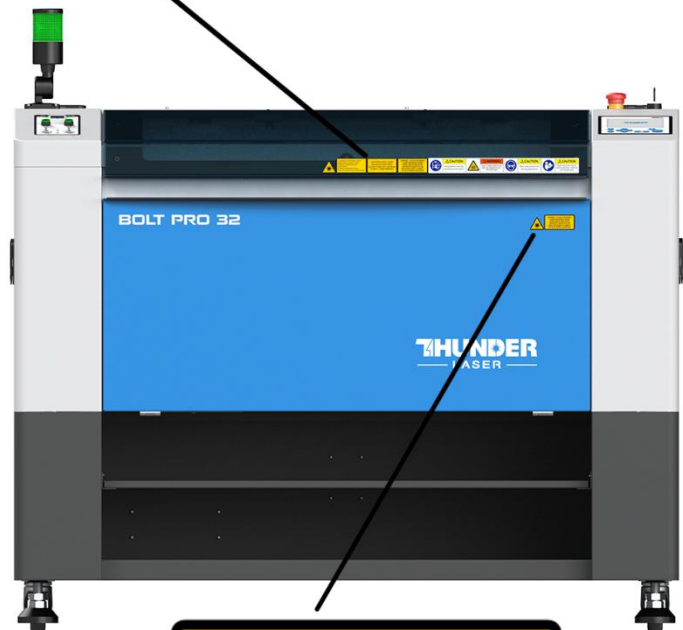

DANGER - CLASS 4 INVISIBLE  
LASER RADIATION WHEN  
OPEN AND INTERLOCKS  
DEFEATED AVOID EYE OR  
SKIN EXPOSURE TO DIRECT  
OR SCATTERED RADIATION



**⚠ ATTENTION**

**Function of the signal lamp**

**Solid Red Light:** The Laser machine is busy running a job or an alarm is present while running such as Doors Not Closed, High Heat Alarm, Low Air Assist Pressure.

**Blinking Red Light:** Operator has bypassed the door safety system. The operator must stay near the laser machine while it is busy running or door safety systems are bypassed.

**Solid Green Light:** Laser machine is idle and is ready for Operation. The machine will accept new job file transfers and no alarms are present.

**Buzzer :** When the buzzer is beeping it is indicating a High Temperature Alarm on the Honeycomb table >55°C(131°F). The sound is Roughly 80dBA at 1m, 70dBA within 5m and 65dBA within 10m. Immediate action should be taken to mitigate the High Temp Alarm.



**⚠ CAUTION**  
Dangerous voltage!  
Take care to avoid coming into contact with electricity!

**DANGER - CLASS 4 INVISIBLE LASER RADIATION WHEN OPEN AND INTERLOCKS DEFEATED AVOID EYE OR SKIN EXPOSURE TO DIRECT OR SCATTERED RADIATION**

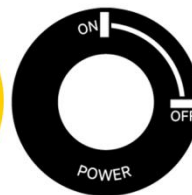

**⚠ ATTENTION**

- The operator must read the operation manual carefully before operating the machine. Do not operate this machine without training.
- Never leave the laser running unattended, and turn off the power to the machine when the job is complete.
- Keep an eye on the machine while it is running and be prepared to pause the process, using an emergency stop if necessary.
- This machine contains multiple risks of invisible laser radiation (heat) and high voltage. In the case of a fault, never try to disassemble the machine, contact service provider and turn off power.
- Make sure the machine is well grounded before operating it.
- Service, maintenance and repairs must be performed by trained professionals.
- Do not operate this laser machine with any covers open, or attempt to defeat any safety interlocks. If so can cause burns and possibly permanent damage to your vision.
- The environment conditions of your production facility are crucial to the machines potential lifespan. Specifically avoid high humidity, airborne dust and fluctuating temperatures. Do not allow the machine to freeze.
- Nota:** The optimal environmental temperature for the water cooling system ranges between 59 and 86°F (15 and 30°C). Antifreeze must be added to the water chiller when the room temperature close to 0°C (32°F). Only use distilled water and replace it every 3 months to maintain purity. Any additive put in the water will damage the laser tube seals and the pump inside the water chiller unit. Please ensure the laser tube is full of water and no bubbles after the cooling system is running.
- Odin:** The air inlet of the air cooling system is installed with dust-proof sponge, which is recommended to be cleaned once a month to ensure good heat dissipation of the laser source.
- Do not store any flammable materials on or near the laser. The laser uses invisible radiation (heat) to vaporize/burn/ablate materials. Fire is a known risk with CO2 lasers.
- Regular cleaning of reflective mirrors and the focusing lens is essential to prevent power weak.
- Remove offcuts and waste material from the interior of the machine, and regularly check and clear the extraction system to prevent buildup of soot and dust which can fuel a fire.
- Do not attempt to mark or cut reflective materials with CO2 laser. This can result in reflected invisible laser radiation (heat), which will damage the machine.
- Keep a serviced CO2 fire extinguisher nearby the laser always. Dry power extinguishers will cause irreparable corrosion if used.
- In the event of any uncontrollable event or failure of your system, always contact your service provider for professional assistance to resume work in a timely and safe manner.

Thank you for your cooperation!



**DANGER - CLASS 4 INVISIBLE LASER RADIATION WHEN OPEN AND INTERLOCKS DEFEATED AVOID EYE OR SKIN EXPOSURE TO DIRECT OR SCATTERED RADIATION**



**⚠ CAUTION**  
Dangerous voltage!  
Take care to avoid coming into contact with electricity!

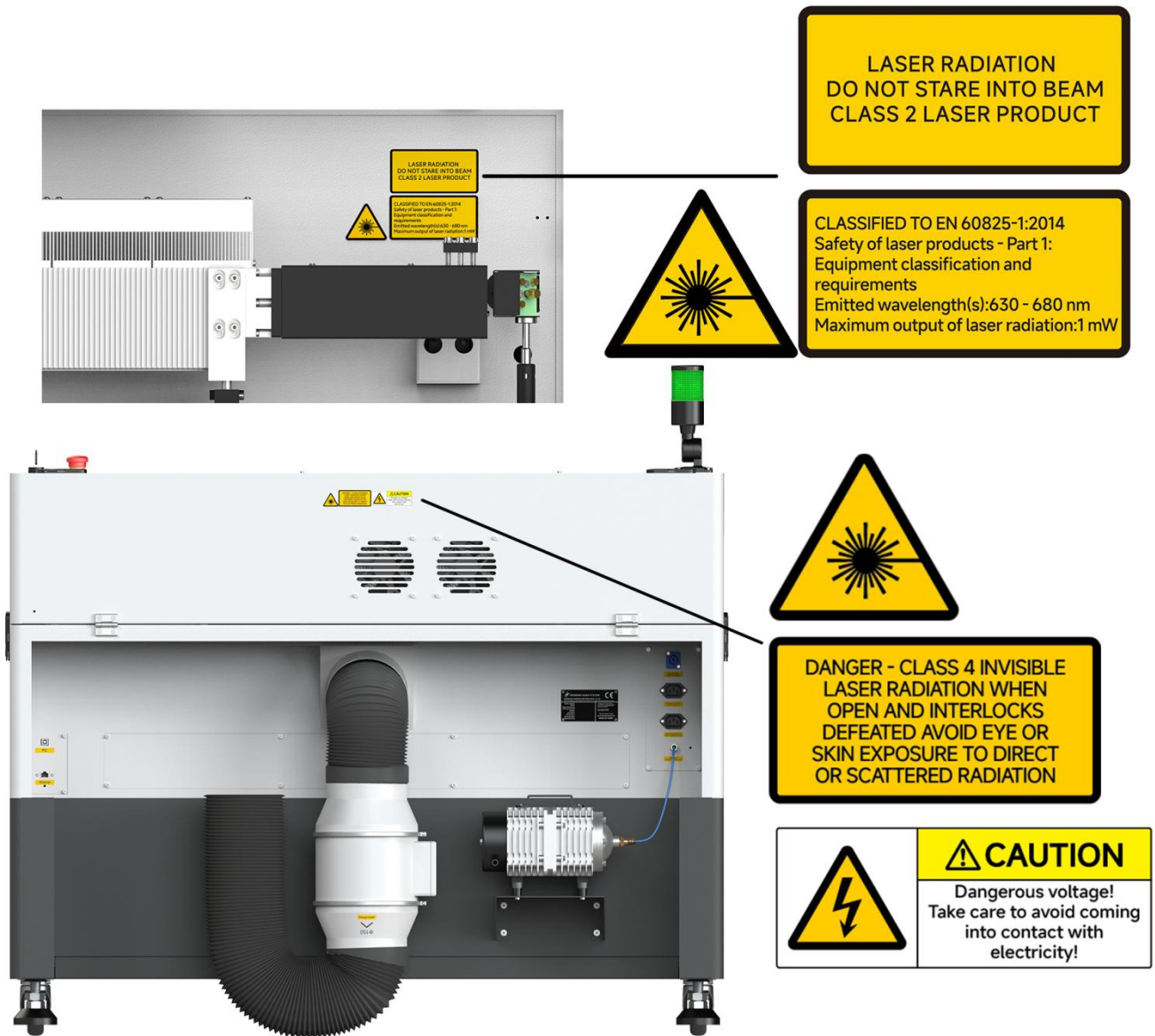

**LASER RADIATION**  
DO NOT STARE INTO BEAM  
CLASS 2 LASER PRODUCT

CLASSIFIED TO EN 60825-1:2014  
Safety of laser products - Part 1:  
Equipment classification and  
requirements  
Emitted wavelength(s): 630 - 680 nm  
Maximum output of laser radiation: 1 mW

**DANGER - CLASS 4 INVISIBLE**  
LASER RADIATION WHEN  
OPEN AND INTERLOCKS  
DEFEATED AVOID EYE OR  
SKIN EXPOSURE TO DIRECT  
OR SCATTERED RADIATION

**⚠ CAUTION**  
Dangerous voltage!  
Take care to avoid coming  
into contact with  
electricity!



## Chapter 3. Process of Installing

### 3.1 Unpacking

You receive your THUNDER LASER Thunder Bolt Pro SERIES packed in a wooden box which contains the laser machine and additional accessories. The following steps give you an overview of the unpacking and assembly of the laser. Please follow these steps carefully.



Keep the packing box. You will require it in case of a return.

Dispose all waste according to the applicable waste disposal law.

1. Put the wooden box on a flat and spacious room for unpacking.
2. Remove the machine box; carefully remove the protective foam, wraps, films, etc...
3. You will see an accessories box which contains all accessory parts required for the installation of the laser machine and check the contents carefully.
4. Remove the sponges and nylon cable ties from inside the machine, and then start to install the machine, carefully following the instructions in this manual.

### 3.2 Location

Before you install the laser system, you should select an appropriate location. Follow the guidelines shown below:



1. Avoid locations where the system is exposed to high temperatures, dust and high humidity. (The humidity must not exceed 70% and the temperature must not be close to the dew point.)
2. Avoid locations, where the system is exposed to mechanical shocks.



1. Circuit Breaker protection: Do not connect other devices on the same circuit as the laser system. It requires a dedicated circuit.
2. DO NOT open any of the machine's access panels while the unit is plugged in. Opening a panel may expose the operator to severe electric shock, invisible CO2 laser radiation, mechanical pinch points, burns, blindness, and other hazards. ALWAYS POWER OFF AND UNPLUG!
3. DO NOT make or break any electrical connections to the system while the unit is turned on.



1. Avoid locations with poor air circulation; select a location close to ventilation (if

available). Select a location, whose room temperature is between 15 °C and 25 °C (59° – 77° F).

2. This is fundamental to maintain consistent and reliable operation of a CO2 laser, Metal RF or Glass tube and the machine itself. Avoid higher ambient temperatures and strong exposure of the engraver to the sun. Use blinds, if required.

3. Mechanical shock and vibration of the laser will have detrimental effects on the performance and life expectancy of the machine. It will manifest (over a period of time) with a noticeable decrease in performance and increased maintenance required, possibly even damage. Setting your Thunder Laser up in a suitable temperature controlled, dust free, moisture free, level, stable surface (a level concrete floor) with the recommended extraction is critical to the ongoing performance of the machine. It is also a warranty condition.

### 3.3 Before Installation

1. Remove the nylon cable ties around the honey comb plate.

Remove the transparent bag from the front of honey comb plate, like below:



The transparent bag has a set of USB flash drive, and an engraving test sample. The USB flash drive stores software, manuals, libraries, etc... that you will need.

Reverse Offset/Scan Offset compensation settings for this specific machine are included. **These settings need to be entered into your RDWorks and/or LightBurn settings to ensure the highest engraving quality.** Refer to the Ruida and/or LightBurn Manuals for these necessary procedures.

2. Rotate the E-Stop switch in the direction of the arrows to reset. Familiarize yourself with the emergency stop button's operation and location.

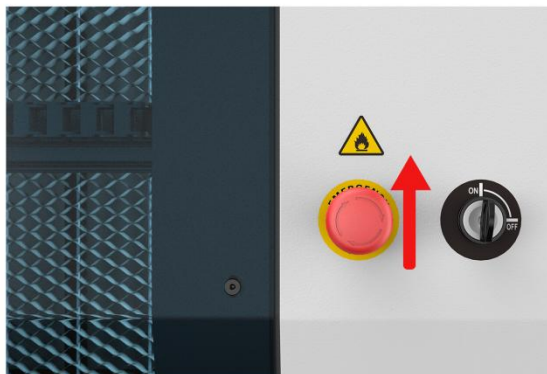

3. When you have the machine in its final position, please be sure to re-fix the feet in all four corners.

Please see below:

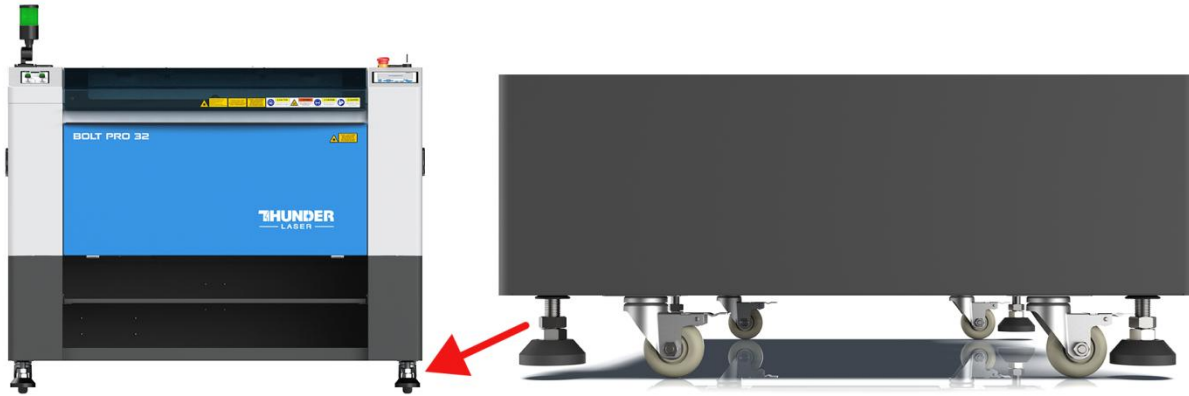

The main power cable is in the tool box that came with the machine.

### 3.4 Exhaust System – Requirements

Proper fume extraction is imperative to evacuate the combustible and noxious fumes that are created during the lasing process. This machine must be equipped with an adequate exhaust system. This includes a blower of rated flow, volume, and duty cycle as well as properly installed ducting and peripherals. You can further reduce smells from fine particulate matter with an inline filtering system.

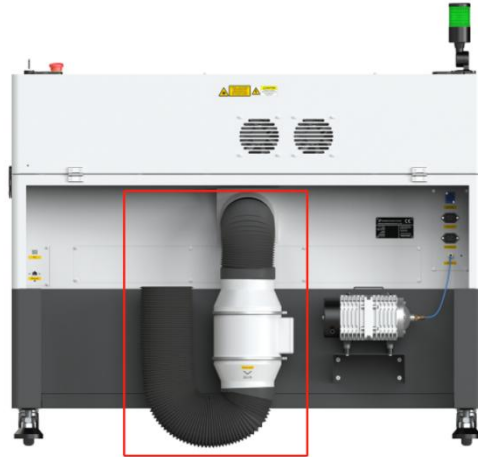

Do not start the machine without an adequate exhaust system.

### 3.5 Air System – Requirements

The included air pump supplies the dual stage air assist control and is a critical component. This helps keep the focusing lens clean and cool during the engraving process. Air assist is also critical when cutting to reduce flame-ups and clear the debris field.

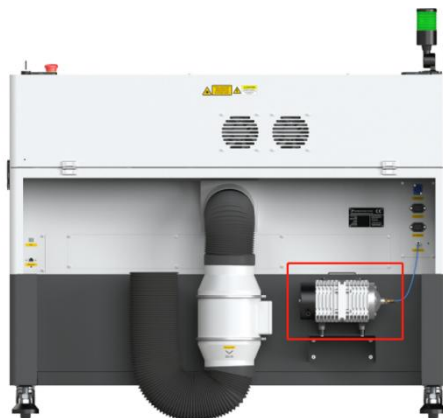

Always use the system's Air Assist feature when vector cutting.

### 3.6 Computer – Requirements

The following recommendation represents the minimum requirements. When using a more powerful computer the graphics are generated and displayed faster and the computing times and the data transfer to the laser are reduced. To use the newest software version, you might have to abide other requirements.

- Windows 11 (32 bit or 64 bit )
- Windows 10 (32 bit or 64 bit )
- Windows 8 (32 bit or 64 bit )
- Windows 7 (32 bit or 64 bit )
  - Windows Vista (with Service Pack 1 or later)
  - Windows XP (with Service Pack 2 or later)
- 1024 MB of RAM, 400 MB of hard disk space
- Pentium® 3 or 4 processor or AMD Athlon™ XP
- 1024 x 768 or better monitor resolution
- 1 free USB interface
- 1 free Ethernet interface
- Mouse

These requirements are for RDWorks. LightBurn software renders jobs thousands of times faster than RDWorks. Check [LightBurnSoftware.com](http://LightBurnSoftware.com) for more information.

### 3.7 Connections



Perform the connections exactly in the order described; otherwise electrostatic charging can damage your computer and/or the electronics of the laser system.

#### 3.7.1 Connecting the Mains

Connect one end of the mains cable with the connection socket at the rear side of the laser device (see Figure below) and the other end with a protected power outlet.

Mains voltage and operating voltage must correspond (AC 115V 50/60 Hz or AC 230V 50/60 Hz) – see information label beside the connection socket.



Under no circumstances should you switch on the device if the voltages do not correspond.

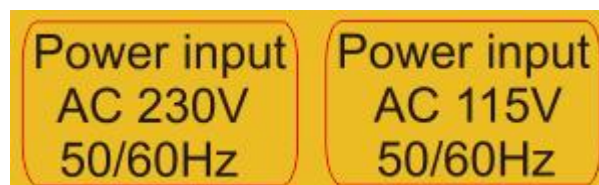
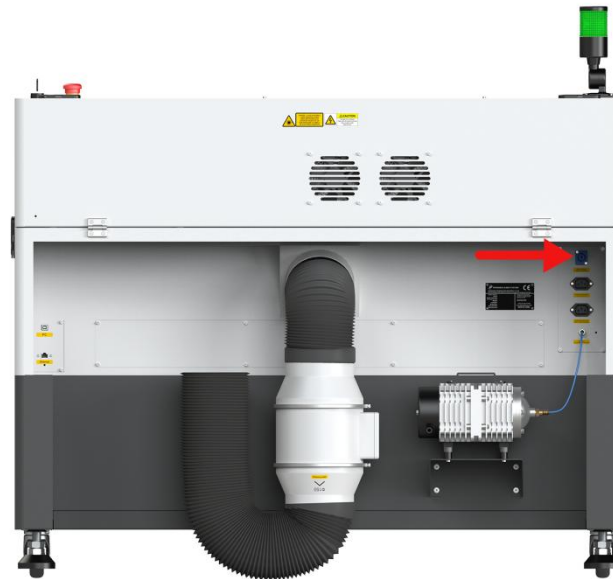

The mains cable is placed in the toolbox.

**3.7.2 Connecting the Computer**

Connecting the Computer and the machine by using the USB cable. Like below:

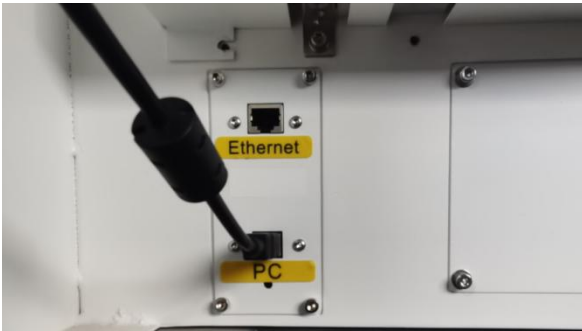

Connecting the Computer and the machine by using the Ethernet cable. Like below:



The USB and Ethernet cable are placed inside the toolbox.



## Chapter 4. Operation

### 4.1 Machine View

#### 1. Top flap

If the Top flap is opened, no data is processed. When the protection cover is opened during working, the motion system is stopped and the laser source is turned off. During processing of commands the protection cover must only be opened after pressing the "Pause" button.

#### 2. Camera

Camera function.

#### 3. Laser head

Laser beam and red dot pointer are all come out from the laser head.

#### 4. Honey comb table

The honey comb plate sits on top of the blade bed and has indexing pins for alignment.

#### 5. Auto-focus sensor

Used for the automatic focusing of the work table.

#### 6. Indicate light

If laser machine is running a job or user starts it without closing door or water protection, the signal lamp is in red light. The red light indicates the dangerous situation and user must stay with the laser.

If laser machine is not at work, the signal lamp is in green light. The green light indicates the safety situation and the laser machine is ready for operation.

If temperature is higher than 55°C/131°F on working table, the signal lamp will make buzzing sound. (roughly 80dBA within 1m,75dBA within 5m and 65dBA within 10m,the sound gets weaker as it travels).

#### 7. Dual air-assist control panel

You can adjust air volume for cutting or engraving if require. (Please view this chapter 4.9 for detail).

#### 8. Left side door

On Thunder Bolt Pro22&32, there are installed the TL-Timer board, Z-axis Motor, Flap sensor checking board etc. Please open this door for checking these parts, but must pay attention to the electric current.

#### 9. Foot stand

Moving or fixed the laser machine.

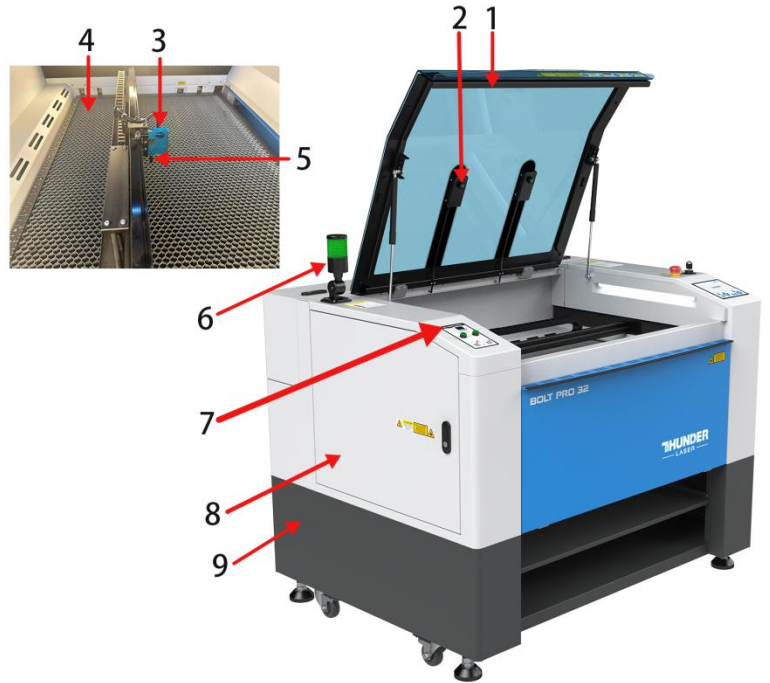

**10. Front door**

To clean the waste after working or remove the honey comb table. This door is installed with the flap protection sensor.

**11. X axis**

The motion system is that performs the mechanical movements in X direction. The X-axis is visible in the working area.

**12. Y axis**

The motion system is that performs the mechanical movements in Y direction. The Y-axis is visible in the working area.

**13. Flap protection sensor**

This is where Open flat protection exist. Laser will stop working once the cover is opened during working.

**14. LCD panel**

You can control the X-axis, Y-axis and Z-axis manually by the display panel, it also shows the working time, power, speed and the whole working time and affords many function options (Please view this chapter 4.3 for detail).

**15. Emergency stop switch**

Once there's an accident happen (laser catch fire, laser out leakage) during working, please turn off this switch immediately. It will be cut off the laser power and motion power immediately.

**16. LED lamp**

It's used for lighting the working table once turn the Main switch on.

**17. Right door**

On Thunder Bolt Pro22,32, there are laser controller, drive (5 phase open-loop motor driver and Stepper Drive ), power supplier(24V&36V) etc. Please open this door for checking these parts, but must pay attention to the electric current. If you need to repair, please contact with professional maintenance staff.

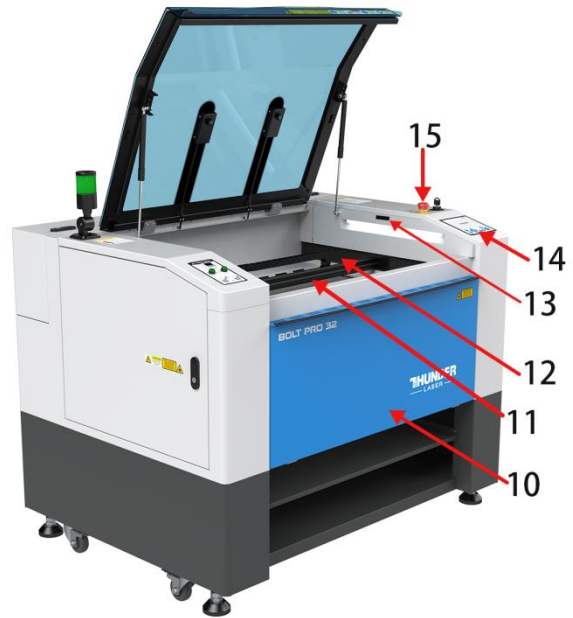

**18. U-disk connection port(USB)**

You can save the file as a U-disk File by press "SaveToUFile" on the software, then save it to the u-disk and insert the u-disk to the port of laser machine, then use the control panel to select and control it to work.

**19. Key switch**

To turn on the machine.

**20. PC connection port(USB)**

This USB is for connecting computer.

**21. Ethernet port**

This Ethernet port is for connecting computer.

**22. Blow air port**

This port is for connecting hoses of the air compressor.

**23. Manufacture's Label**

It's Show you the laser information like serial number or manufacturing date etc.

**24. Laser supply socket**

To connect the main power and the extend power according the label information.

**25. Cooling fan**

Radiating the RF tube.

**26. Exhaust hose**

This is for installing the exhaust device.

**27. Laser tube cover**

There are installed the laser tube, red dot pointer device, beam combiner and the first reflective mirror mount. This door is installed with the flap protection sensor.

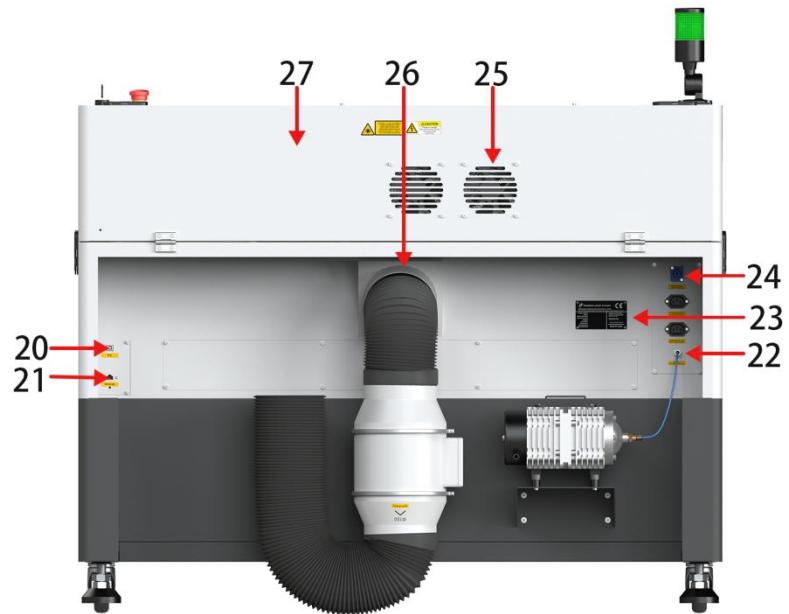

## 4.2 ON/OFF Switch

The mains power ON/OFF switch

The following conditions must be fulfilled for correct start up:

Unrestricted freedom of motion of the mechanics

No materials under the engraving table

Protection covers closed

Then turn the key switch to on



Then this page will pop up.

Starting Program

The following steps will be performed:

- Power on the laser
- Move the laser head to origin

Confirm and move

Click **“Confirm and move”**

If all covers are closed, immediately after being switched on, the device starts the referencing process. When the referencing process is completed correctly, an acoustic signal sounds and the device is ready for operation. The operation panel will display the home screen when the laser is completed resets.



Before switching on the device, the user must make sure that no objects of any kind are located inside the operating space, which could limit or obstruct the mechanics of the device.

### 4.3 How to setup the OEM software

**PLEASE VISIT LIGHTBURNSOFTWARE.COM TO FIND RESOURCES FOR INSTALLING  
LIGHTBURN**

#### 4.3.1 Software installation

Your machine comes with a USB flash drive, which you will find many helpful application videos and instructions as well as the software for your machine.

To install the software, insert the USB flash drive into your PC and open the "Software" folder on the USB flash drive.

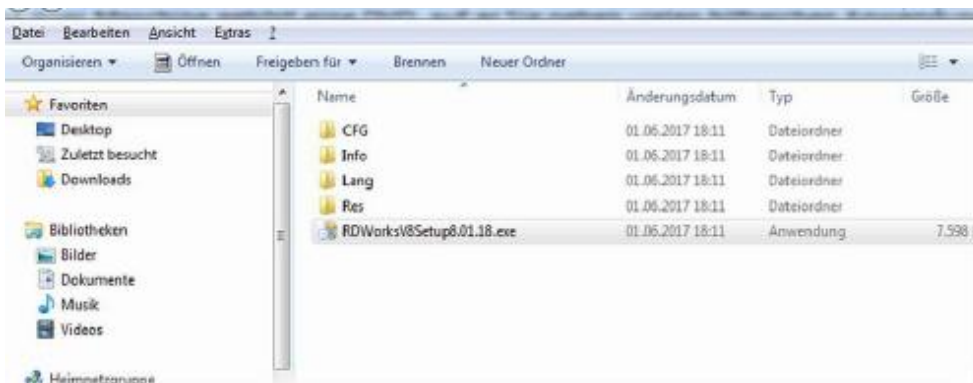

In this folder you will find the installation file "RDWorksV8Setup8.01.50.exe". Run this file by double-clicking on your PC.

Follow the installation menu until the window "Welcome to use" opens, like below.



If you use USB cable connection, please install the USB driver.

The type of the program offers different possibilities:

1. LaserWork: If you select this option, the laser software RDworksV8 will be installed on your computer.
2. CorelDraw\_Laser: If you work a lot with Corel Draw, you can transfer your images and drawings directly to RDworksV8.
3. AutoCAD\_Laser: Select this option to install a plugin that can transfer the drawings directly from AutoCAD to RDWorksV8.
4. EngraveLab\_Laser: Select this option and install a plugin that can transfer the drawings directly from EngraveLab to RDWorksV8.

Origin (zero point): This is specified by the machine and must always be selected "top-left" for Thunderlaser machines.

Size unit: Here you can choose between millimeters and inches.

Select installation path: Here you can select a different installation directory for your laser software. We recommend that you use the default settings, otherwise some operating systems may restrict the functionality of the software due to misinterpreted access rights.



After selecting your options, click "Install" and then brings up a window "Install Finish!". You can confirm this and then end the installation process.

A "RDWorksV8" icon will be automatically added to your Desktop, you are now ready to use the RDworksV8.



Trouble shooting for RDworks installation.

If you were unable to install the RDworks, it's possible that your Anti-Virus software is blocking installation.

Please disable all Virus and Spyware Protection Features. After the RDworksV8 has been installed go back into your Anti-Virus software and re-enable the setting that was disabled.

#### 4.3.2 Make connection between PC and machine

- USB cable connection

Make sure that you have the USB driver installed during the installation process.





Make sure that you have your PC connected to the machine via USB cable,

Open RDworks, from right bottom corner of the software, set up the Device by Setting>>Device --- (USB: Auto).

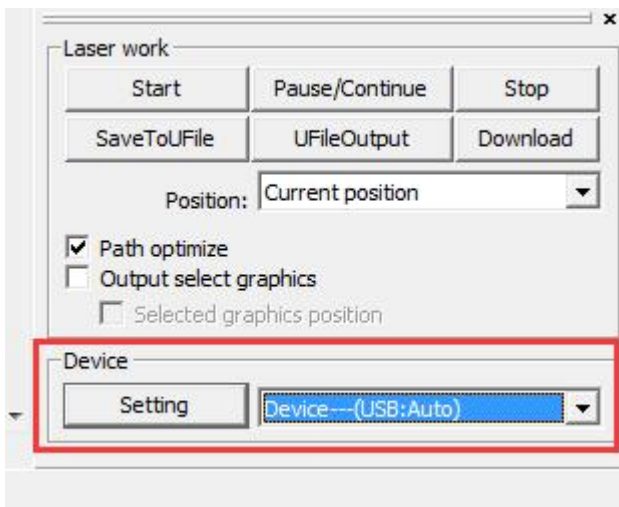

Your PC is now connected to the machine.



When connecting the machine and the PC for the first time, it may take a few minutes for the operating system to recognize the machine and install the driver.

- Ethernet cable connection

Make sure that you have your PC connected directly to the machine via Ethernet cable,



The machine is already assigned an IP address when delivered: 192.168.1.100

Now set up your PC so that it is in the same network and can communicate with the machine.

Please follow the instructions below for the setup process (For Windows7):

- 1) Click Windows Start > Control Panel.
- 2) Click **Network and Internet > Network and Sharing Center**. In the left pane, click **Change adapter setting**.

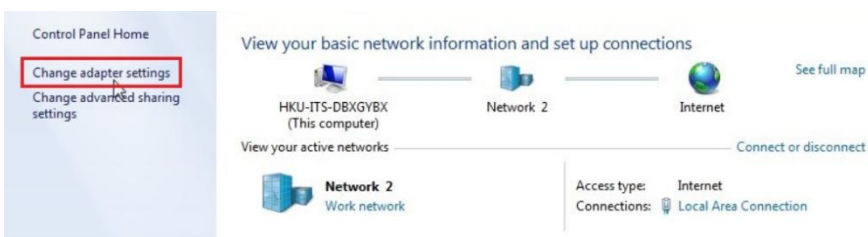

- 3) Right click **Local Area Connection** and then select **Properties**.

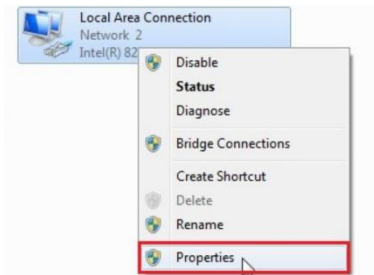

- 4) Under **Networking** tab, choose **Internet Protocol Version 4 (TCP/IPv4)** and then click **Properties**

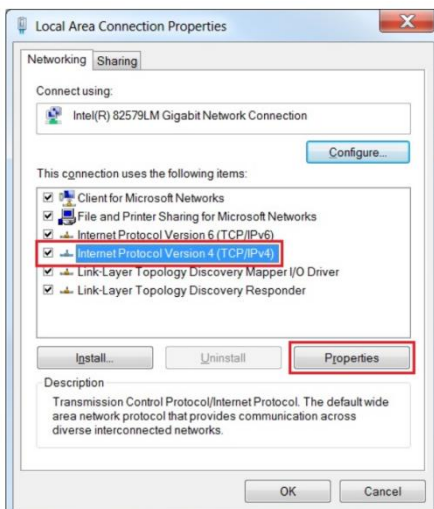

- 5) In "Internet Protocol Version 4 (TCP/IPv4) Properties" window, select "Use the following IP address:"

Type IP Address: 192.168.1.1

And Type subnet mask: 255.255.255.0

[www.thunderlaser.com](http://www.thunderlaser.com)

[tech@thunderlaser.com](mailto:tech@thunderlaser.com)

Tel: (86) 18103043363



Then click OK.

With this you have successfully created the prerequisites so that the machine and the PC can communicate via LAN. Now open your RDWorks from right bottom corner of the software, set up the Device by Setting>>Device --- Add a "Device---(IP:192.168.1.100)".

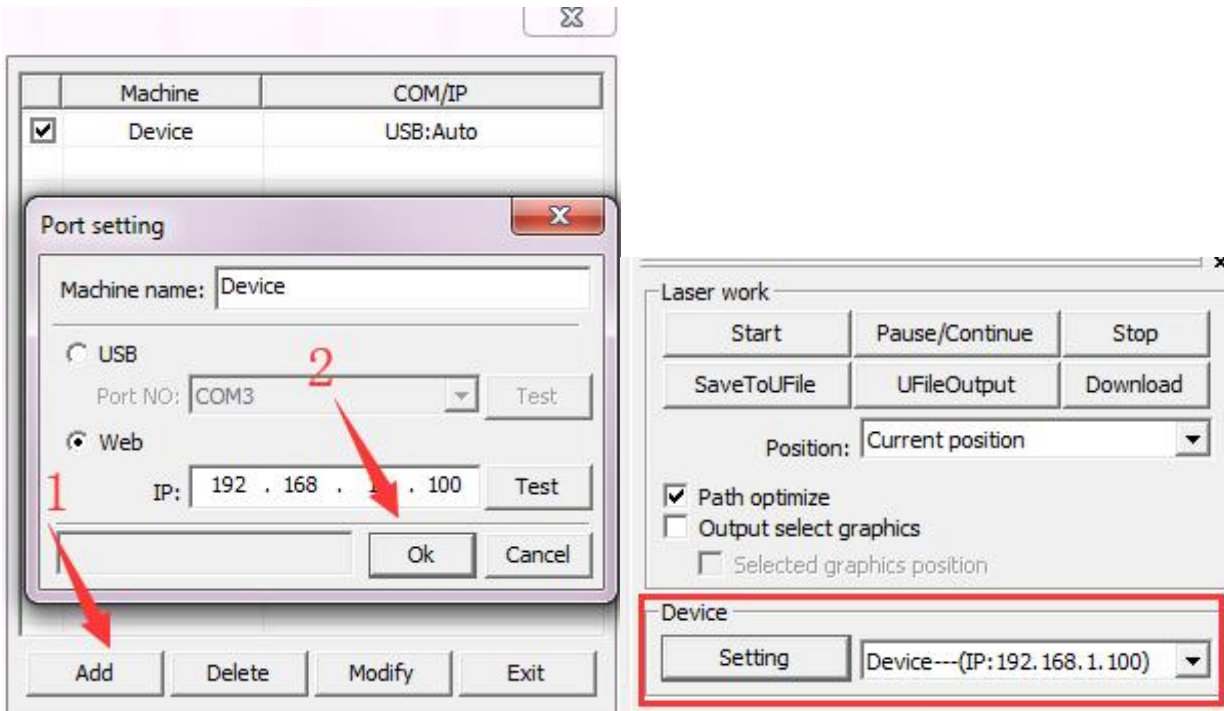

Now RDWorks communicates with your laser machine via LAN.

## 4.4 How to use the display

### 4.4.1 Function of the Buttons



✧ Arrow buttons: control the movement of the Z-axis.



✧ Arrow buttons: control the movement of the laser head.



✧ U movement button: Use this to control the rotary.



✧ Start-Pause/Stop button: Use these buttons to start or pause a file.



✧ USB disk connector: To connect a U-disk

#### 4.4.2 The main interface

- Home page

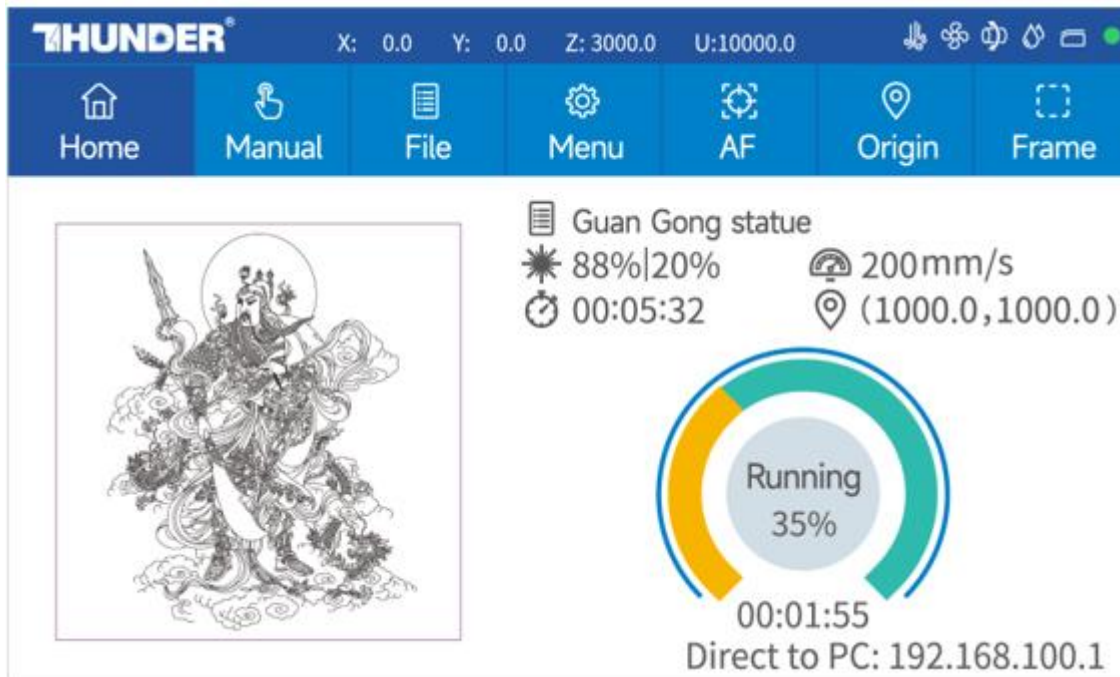

Name: The name of the file.

Power setting: Max power and min power.

Speed setting: Running speed of your job.

Working time: The running time of this job.

 Coordinates: The coordinate of origin you set.

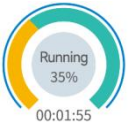



Processing progress: Check the processing status of the job.

Direct to PC: 192.168.100.1 IP address: Show the IP address of machine.

 Air assist: It will be displayed when the machine is in standard mode. Intelligent mode as default settings.

 Exhaust: It will be displayed when the machine is in standard mode.

 Rotary: It will be displayed when the rotary is connected.

 Water protection: Only for DC tubes.

 Door protection status: All doors are closed when it's gray. It's red when a door is opened.

 Status: It's green when the machine is idle. Red when running a file.

● **Manual page**

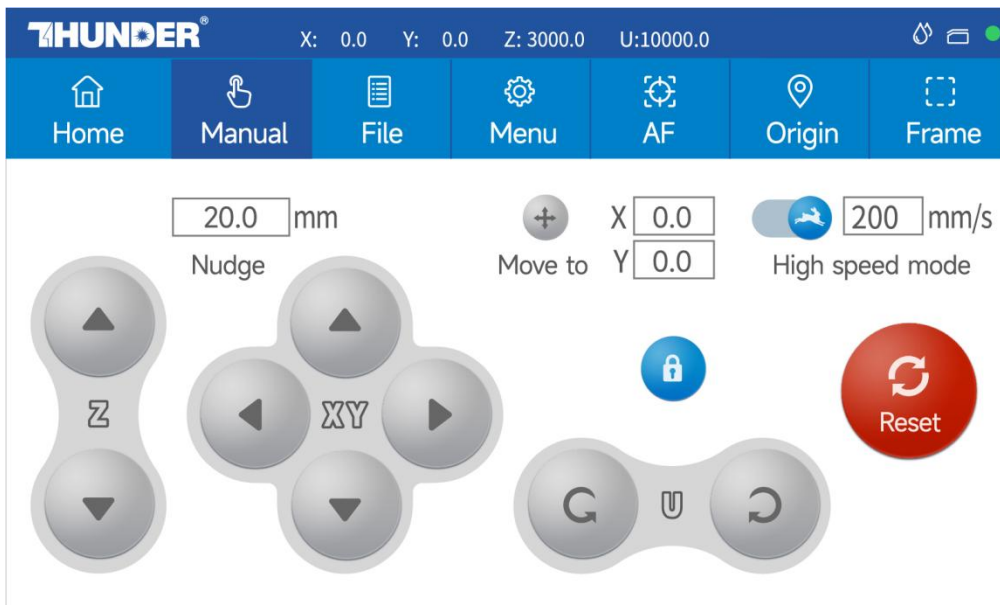

mm  
Nudge: Set the travel distance when moving each axis manually.

 Move to X   
Y   
Target position: Set a coordinate, then the laser head will move to here.

 200 mm/s  
High speed mode

Mobile mode: Change the mode.



Reset button: To reset X/Y axes.



Lock button: Lock or unlock the manual buttons.

● **File page**

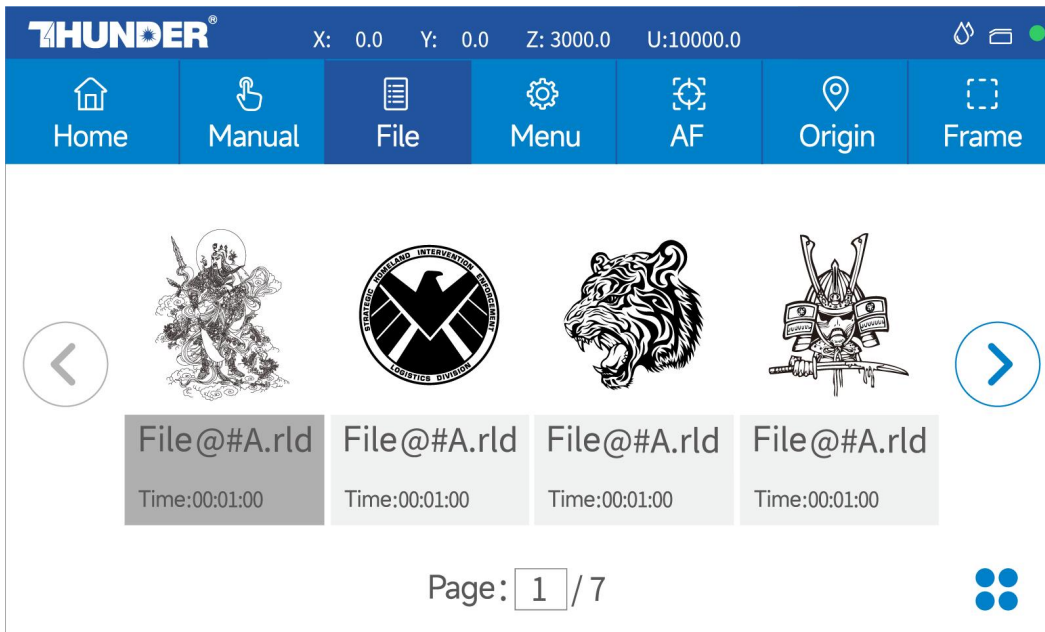

Check all files in this page.



Settings: check more settings of file.



Select and hold a file for 2 seconds to select it to run.

● Menu page

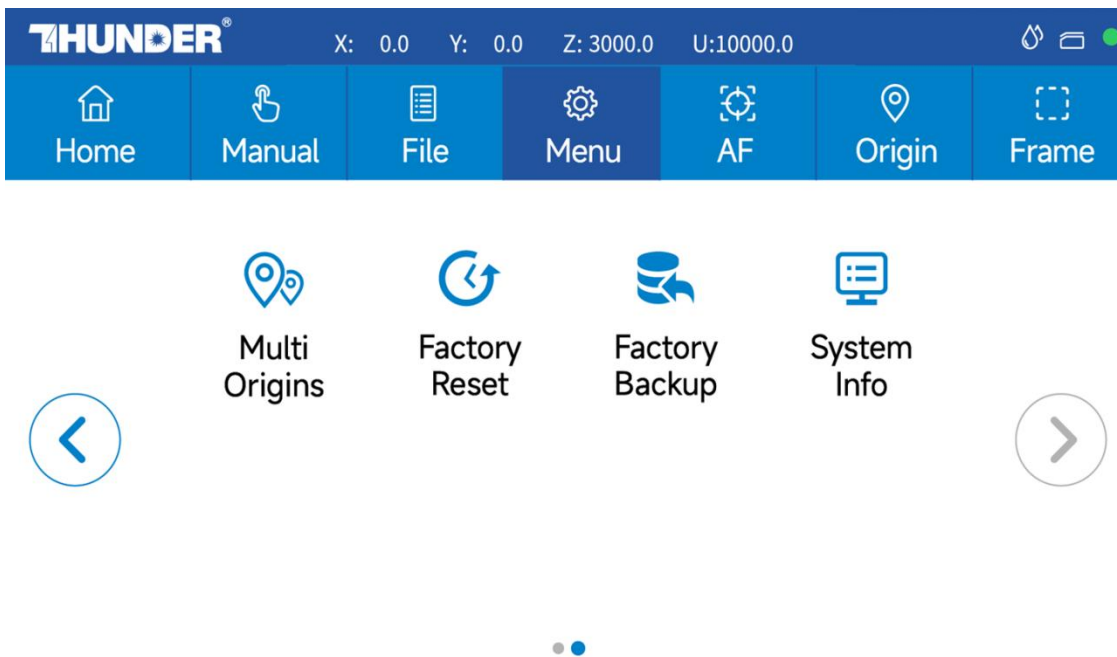
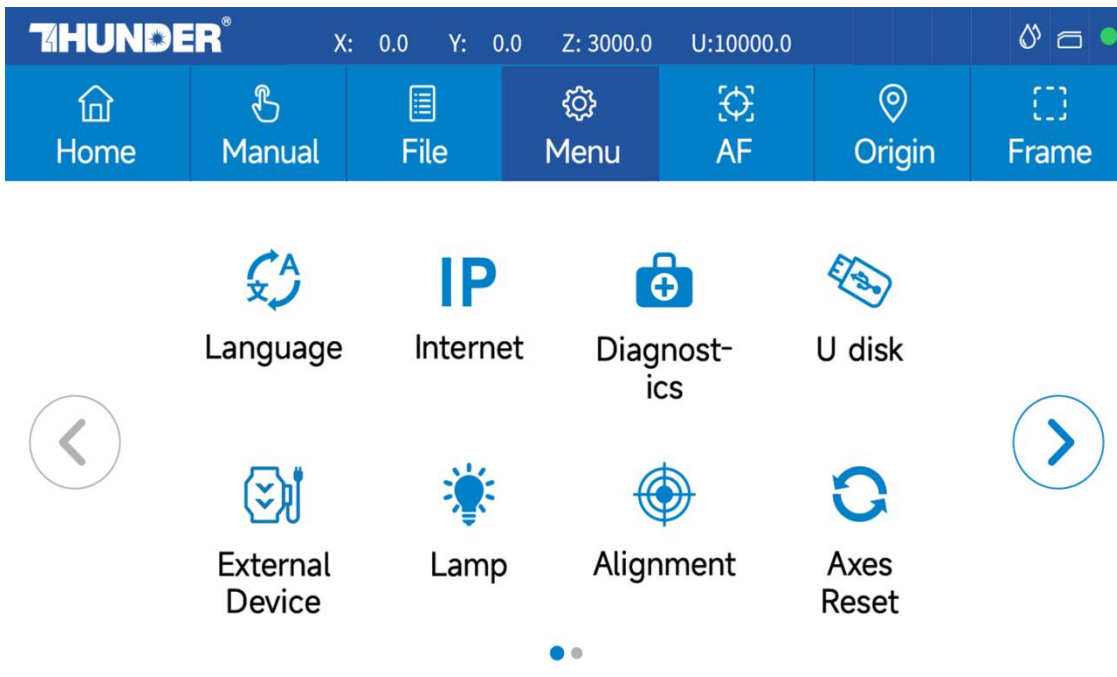

**Language:** Change the language of panel.

**Internet:** Set the IP address.

**Diagnostics:** the “Diagnostics” interface shows some system input information, such as limiter status, and the status of the door protection etc.

**U disk:** Upload files via U-disk.

**External Device:** Switch the intelligent and standard mode. And set delay time for exhaust and air assist time.

**Lamp:** Adjust the brightness of led lamp.

**Alignment:** Check and adjust the laser beam.



**Axes Reset:** Reset all axes.

**Multi Origins:** Set multi origins.

**Factory Reset:** Reset the vendor settings.

**Factory Backup:** Set the current setting as vendor settings.

**System Info:** Check all info of your Thunder.

● **Others**



Auto focus button: Click this button to auto focus after placing the materials on working bed.



Origin button: Click this button after selecting a file.



Frame button: Click it to run a frame of your file after setting an origin.

## 4.5 How to adjust focus distance by manual or auto

### 1) How to adjust focus distance by manual

Find the Focus Tool for help to adjust the focus directly like below:

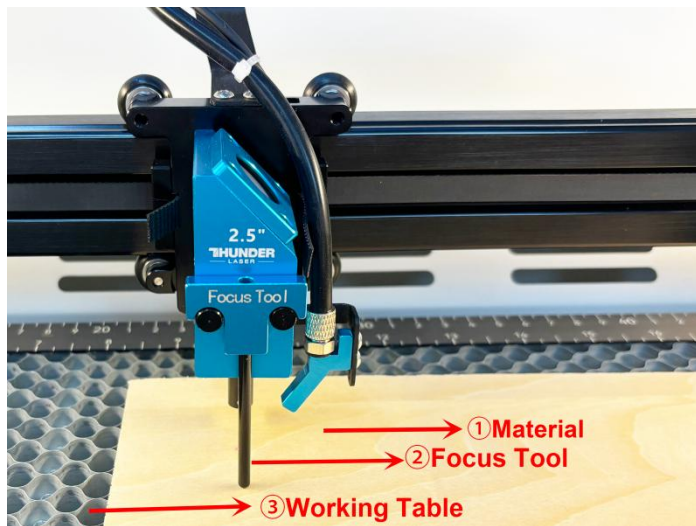

- ① Material
- ② Focus Tool
- ③ Working Table

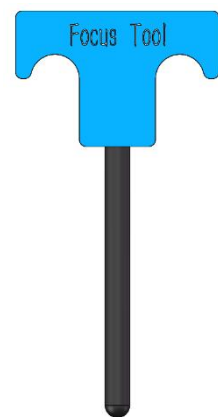

The focus length for all lens(1.5",2", 2.5"&4") are the same, just need to using this focus tool.

**2) How to adjust focus distance by Auto-focus tool**

Auto focus function can move up and down the working table to make sure the most proper distance between the material and the focal lens.

By using the auto focus function, users can focus quickly and accurately before cutting and engraving which saves the time of cutting and engraving and brings the better cutting engraving result.

1. The position of the autofocus tool is shown in the picture below:

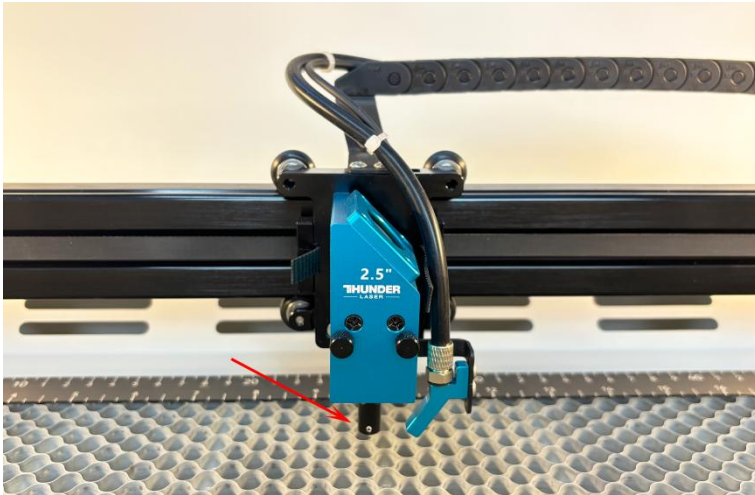

2. Please follow the steps below to use the Auto focus function

Move table down till there's enough space>>Place the material on the table>>Move laser head over the material>> go into Menu button>>Select Auto Focus.

After that, the needed focus will be set automatically.

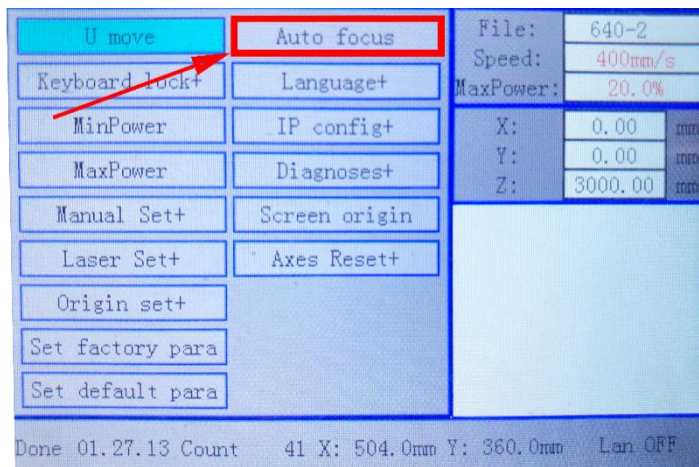



## 4.6 How to use the different optional lens(1.5" & 2"& 4")

1.5" & 2" & 4" lens are optional item.



For different lens, the installation positions are different.

### 1.5" lens



**2" lens**



**4" lens**



## 4.7 How to use the TL-Timer

The TL-Timer is an additional tool for laser machines.

It will control laser machines periphery like air pump, exhaust fan, warning lights, heat alarm detector, electrical locks and lot of other stuff automatically.

This will increase the ease of use of your laser machine.

Please note the different types of connection, which makes the TL-Timer able to work with each kind of laser controller.

### About TL-Timer controller interface and buttons description:

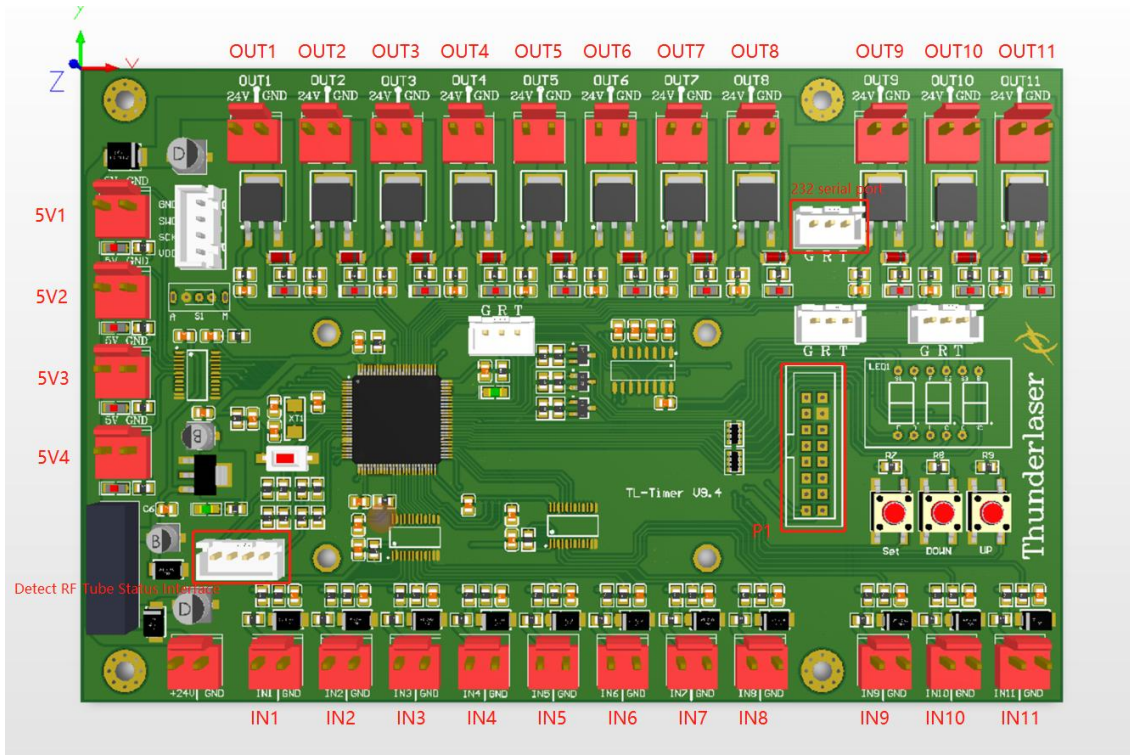

#### 1. Thunder Bolt Pro port description:

##### 1) Input port description:

- ① Input port 1:Spare;
- ② Input port 2:Temperature detection;
- ③ Input port 3:Spare;
- ④ Input port 4:Control air assist with "Low volume";
- ⑤ Input port 5:Control air assist with "High volume";
- ⑥ Input port 6:Temperature detection;
- ⑦ Input port 7:Spare;
- ⑧ Input port 8:Dual air assist system icon on shield panel;
- ⑨ Input port 9:Normally closed emergency stop switch;
- ⑩ Input port 10:Normally closed emergency stop switch;
- ⑪ Input port 11:Spare.

**2) 24V Output port description:**

- ① Output port 1:Control the green light of warning light; when the machine is not at work, it's green;
- ② Output port 2:Control the red light of warning light; when the machine at work, it's red; Red light flashes when door cover protection is on;
- ③ Output port 3:Control the exhaust fan;
- ④ Output port 4:Control air assist with "Low volume"; Delay shutdown is set to 20s(Factory default settings, change it if required);
- ⑤ Output port 5:Control air assist with "High volume"; Delay shutdown is set to 20s(Factory default settings, change it if required); Output port 6: Connect the buzzer; after triggering the temperature alarm, close IN6, OUT6 outputs 24V and turns on the buzzer;
- ⑥ Output port 7:Control the 36V power input to the rotary unit;
- ⑦ Output port 8:Connect the RF tube and 36V power supply;
- ⑧ Output port 9:Control the 24V supply to the X/Y axis drive;
- ⑨ Output port 10:Control the left and right LEDs. Set brightness 20%-100% on the operation panel, OUT10 output 24V; set brightness 0%, OUT10 does not output 24V;
- ⑩ Output port 11: Spare.

**3) 5V Output port description:**

- ① Output port 5V1: Control red light pointer;
- ② Output port 5V2: spare;
- ③ Output port 5V3: spare;
- ④ Output port 5V4: spare.

**4) Detect RF Tube Status Interface:**

Communicating with the FanCtrl board.The laser status is feedback to the TL board via the FanCtrl board.

**5) P1 interface:**

Connection of door sensor checking board; Feedback of door cover status to TL control board.

**6) 232 Serial port:**

Communicate with controller board, show the working status of the some parts on the panel.

## 4.8 How to use air-assist control

The Air-assist control is an additional tool for laser machines.

Generally, cutting needs the air assist with high air-volume but engraving needs the air assist with low air-volume.

Air-assist control is available in high- and low-volume for engraving and cutting-jobs via software-setting, this will increase the ease of use of your laser machine.

The air pressure sensor is used to detect the air pressure value, making it easier to adjust the airflow volume according to actual needs.



### 1) How to select the air assist with high volume or low volume?

In RDworks software, high volume or low volume is selected on the “Air-Assist Control” option. We suggest select “High” for cut mode and select “Low” for scan mode (engraving mode).

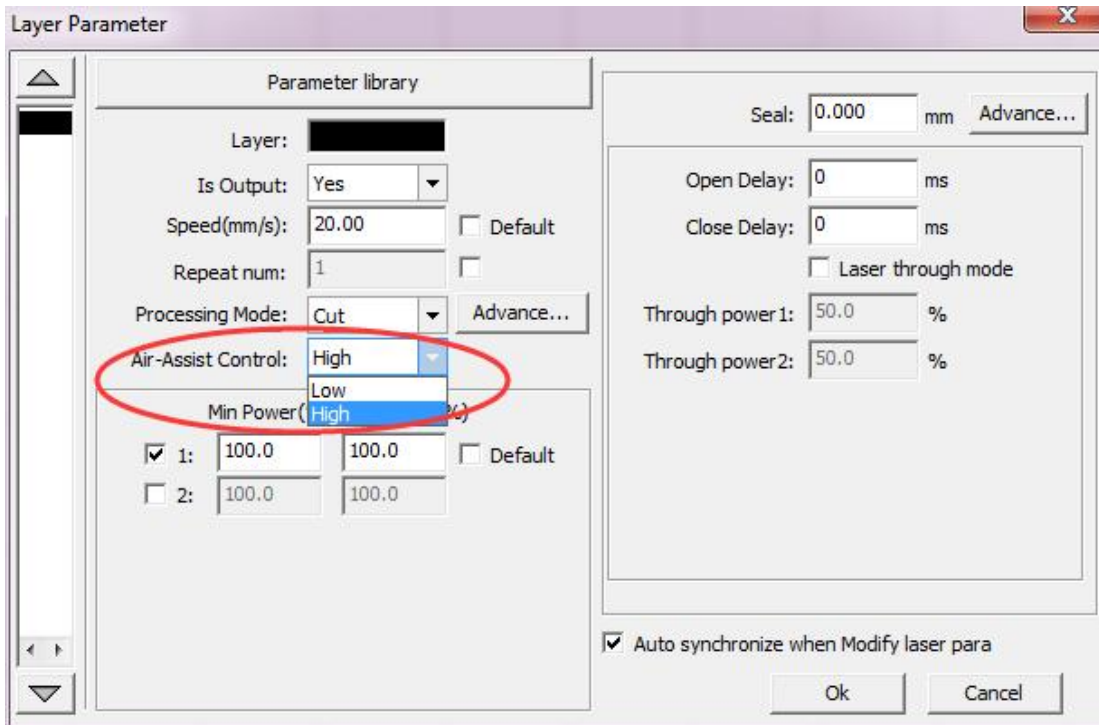

You can also set default for “Air-Assist Control” option, so in cut mode, it will select High volume automatically, and in scan mode (engraving mode), it will select Low volume automatically.

**How to set default for “Air-Assist Control” option?**

Go into the RDworks’s root directory>>open the text file of “soft”>>change the setting of “ShowBlow”>>save the text file, like below.

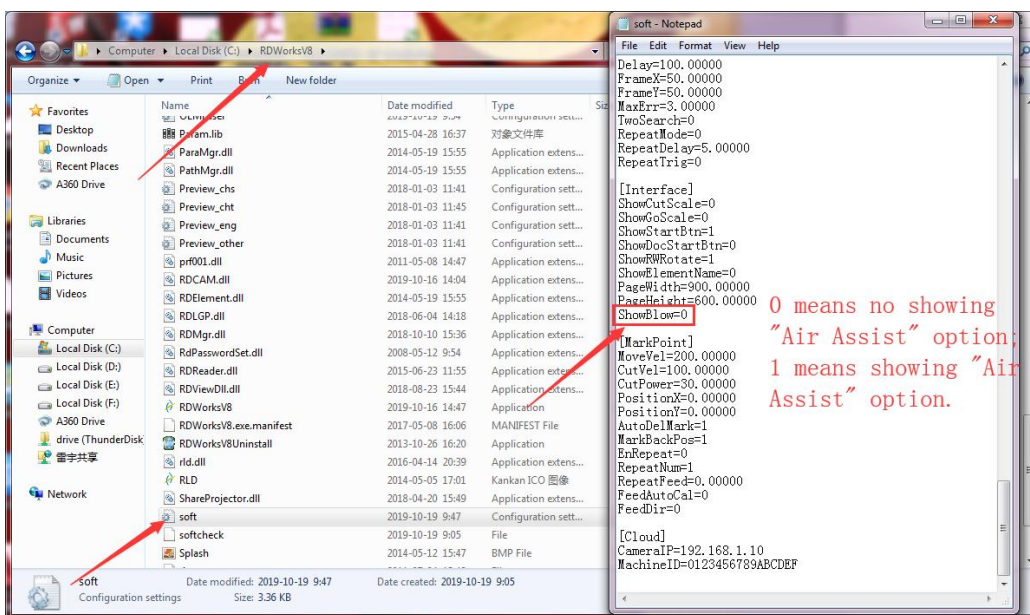

**2) How to adjust air volume if require?**

[www.thunderlaser.com](http://www.thunderlaser.com)  
[tech@thunderlaser.com](mailto:tech@thunderlaser.com)  
Tel: (86) 18103043363



For High volume mode,

1. Make sure machine is not at work and laser switch is off
2. Click the left green button to start the air-assist with high volume
3. Check the air volume under the laser head
4. On left flow control valve, loose the locked nut then rotate the adjusting screw to control the air volume to mean your requirements.
5. Fix the locked nut after finished.

And for Low volume mode, you do it the same.



It will be the best if using big air compressor instead of air pump for air-assist.



Also you can refer to the video instruction below:

<https://youtu.be/GmiphyCBP3w>

## 4.9 How the heat alarm system works

The heat alarm system is an additional tool for laser machines.

Some materials such as acrylic, wood and so on, can easily catch fire, particularly during cutting.

The heat alarm system has a smart board with temperature sensor which will be reacted by an abnormal temperature (higher than 55°C/131°F) on working table. It will trigger at a certain temperature then signals to TL-Timer board to stop laser processing and give a warning sound, so operator can active fire control in time to reduce the potential losses and risks.



The warning sound comes from signal lamp (roughly 80dBA within 1m, 75dBA within 5m and 65dBA within 10m, the sound gets weaker as it travels).

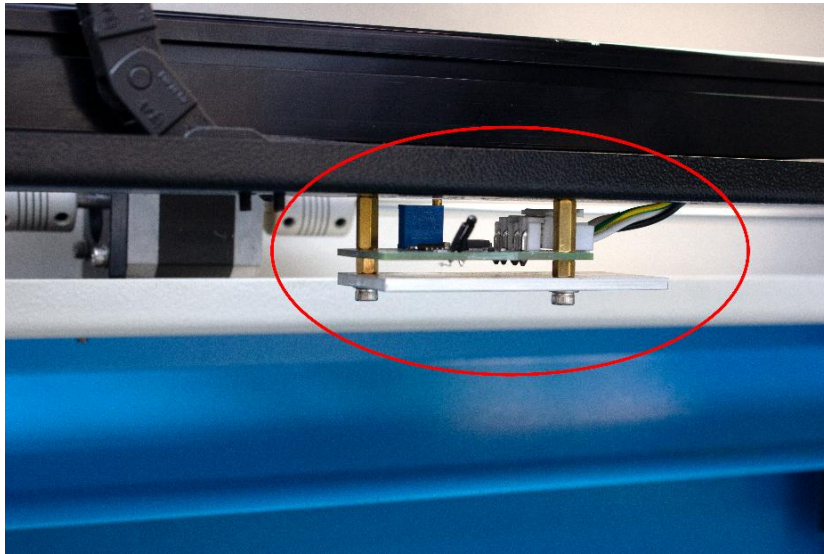

When heat alarm system is activated, the warning sound will beep all the time until user restart the machine.

## 4.10 The First Time Running the Laser



To be safe, never ever run the laser system unattended.



According to international standard, “O” means close; “I” means open for the rocker switch below

### Yours first engraving tests

The following steps describe how to successfully engrave a first pattern. Please follow the individual steps:

1. Switch on you Laser and wait for a beep to note the machine is initialized, and the laser head will do the reset and find the home from top left corner. **DO NOT** click “ESC” button to stop the system initialization.



When turn on the power of machine, and note that turn on the Main switch first and then the Laser switch.

2. After machine finish resetting, adjust the height of working table, place the material usually on the top left corner of the working table.

- ① Move down the working table;
- ② Place the material;
- ③ Move up the working table;

3. With the help of the focus tool, adjust the focus distance to 52.5mm between the focus lens and the material manually by move up and down the working table.

4. Open the software RDworksV8. First to set up the values on the “Scanning(Reverse compensation)” check box.

Open Config(s)>>system setting>>Optimize>>Scanning(Reverse compensation), and there are some default values on the “Scanning(Reverse compensation)” check box.

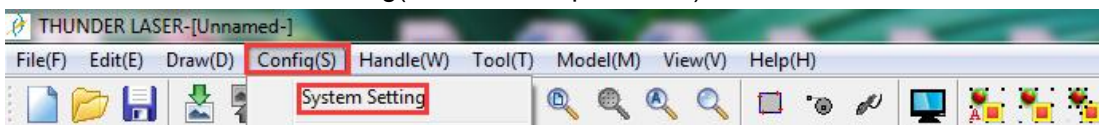

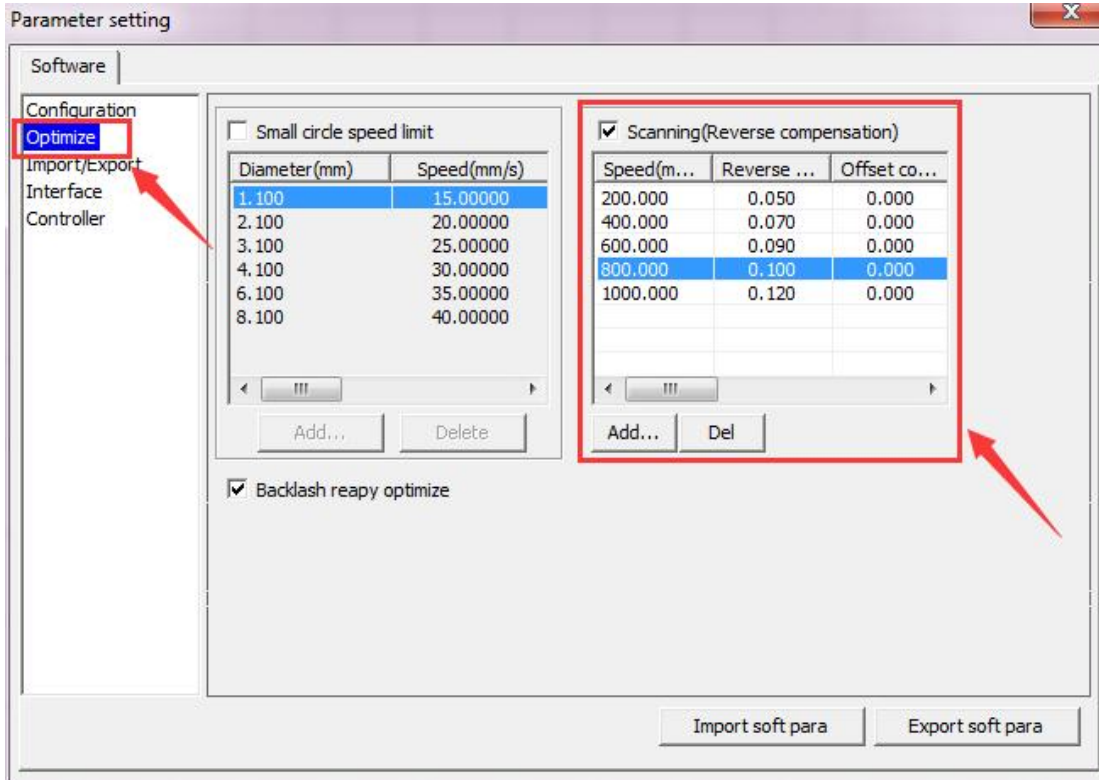

The particular values are showing with a picture in folder of laser software on the USB flash drive and on the Anodized aluminum piece that came with your machine.

Save those setting on the “Scanning(Reverse compensation)” check box.

5. Create sample text for engraving directly on RDWorks, then set up the parameter and download the file to your machine.

More details for how to use software please watch the instruction video below.

[How to prepare your files for feeding into the laser program to engrave \(thunderlaser.com\)](http://www.thunderlaser.com)

6. Click “Original” and “Frame” on the display, please make sure that the material is in the right location and there is enough space for working.

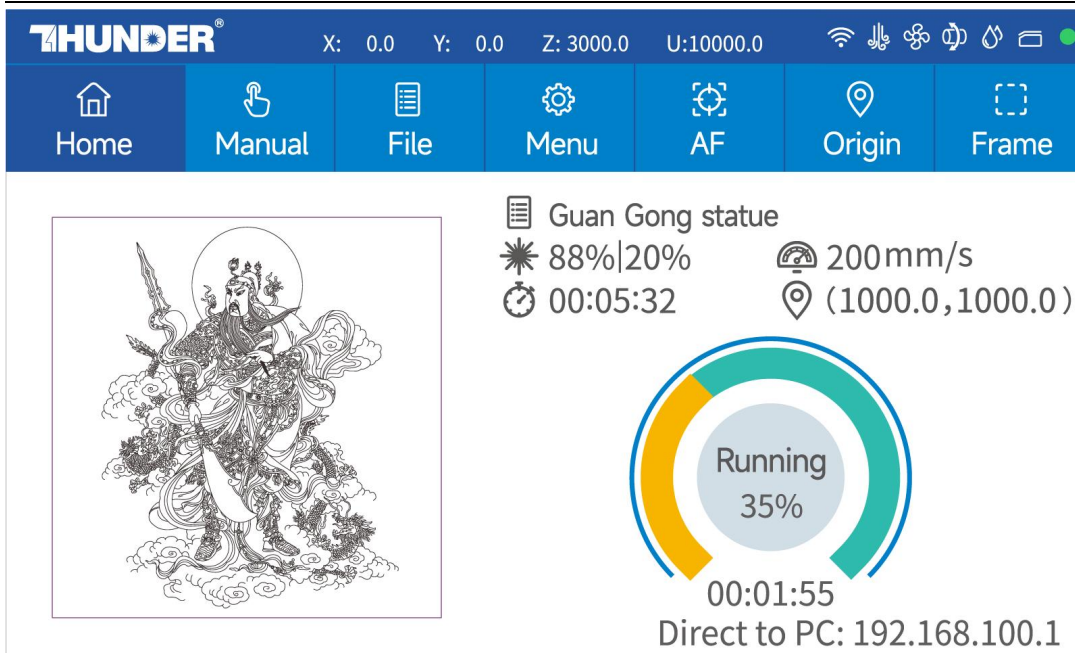

- ① Control arrow button to move the laser head;
- ② Click “Origin” button to select the start point;
- ③ Click “Frame” button to be sure the working area;
- ④ Click “Start-Pause” to run the program;

7. Please check the water cooling system is working properly; the water is running into and filling the laser tube. Please do not start your work if the laser tube isn't full of water, because that may led to laser tube damage due to the high temperature.

8. Finally press the “Start-Pause” button in the display, to start the engraving process.

9. While the laser is engraving, you can generate the next graphic.

10. When the engraving is complete, the laser machine will give out the notification sound and the laser head will go back to the original point, and the warning light will return to the green light, then you can repeat engraving.



This is software specific, so if you are using LightBurn, you will need to do this in LightBurn. It is called “Scanning Offset Adjustment.”



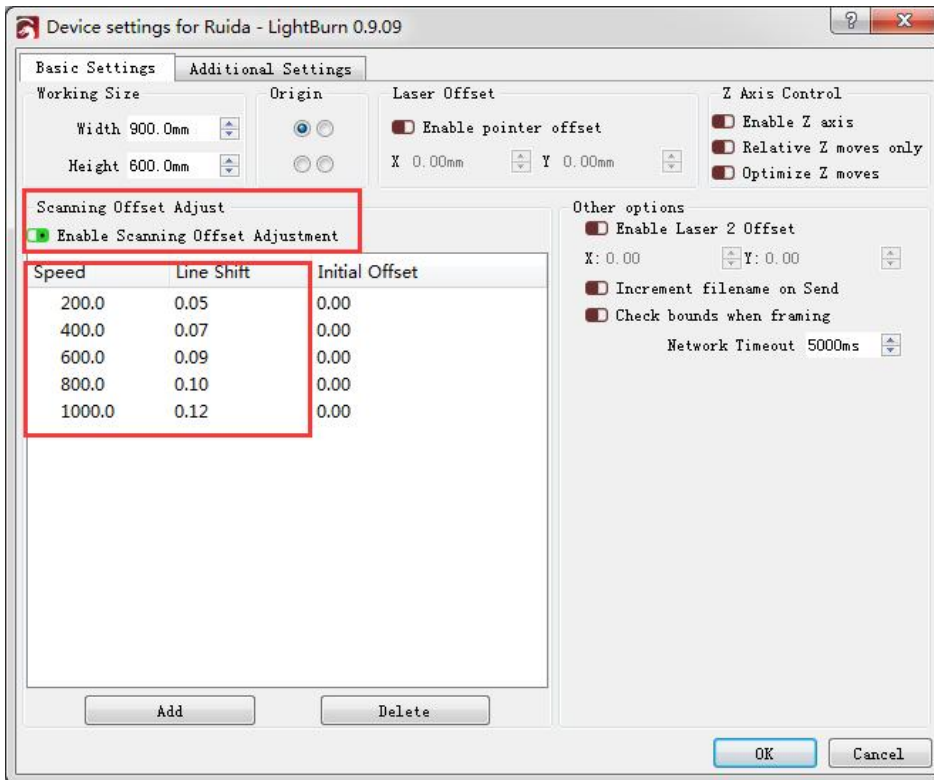

**4.11 Workstation Area Indication**

# Side view



# Plain view





## 4.12 How to use the Chuck Rotary axis Attachment

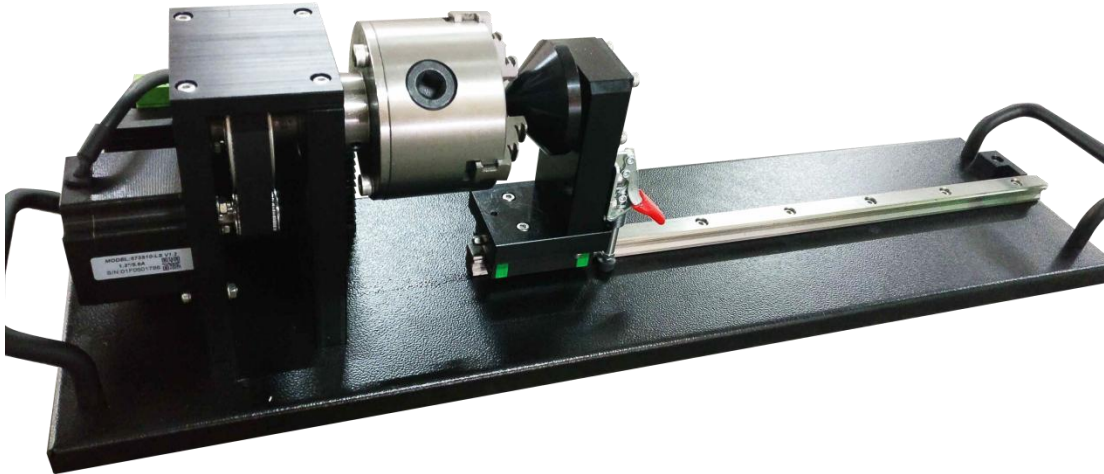

The chuck rotary axis attachment is the optional item.

Specification:

|                      |                                      |
|----------------------|--------------------------------------|
| W×D×H                | 23.62"×6.69"×5.91"/600mm×150mm×170mm |
| Max working length   | 11.42"/290mm                         |
| Max working diameter | 3.94"/100mm                          |

To install and set-up the rotary axis attachment proceed as described as follows:

1. Move the working table to the lower position then switch off the laser and open the top lid.
2. Put the rotary axis attachment onto the working table and align the rotary attachment with the x-axis are parallel, with the jaw chuck closest to where the rotary attachment plugs in.
3. Connect the rotary axis attachment via the control cable with the connector of the motion system. The connector is located inside the right front of the laser. Connected it to this interface and fixed, and then you have finished the device connection. Like below:

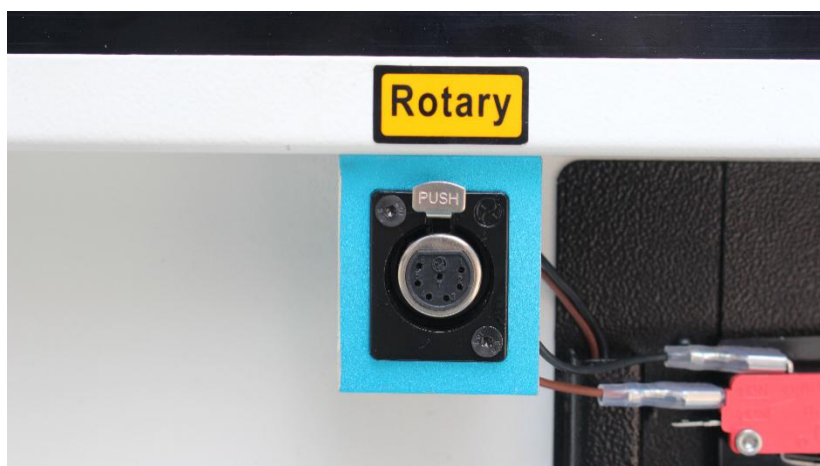

4. Before you mount the object into the rotary axis attachment, measure the diameter of the object at the position to be engraved with a sliding caliper or a similar tool. Write down this value. For example: 80mm.
5. Adjust and fix the slider to make the work piece fitting into the rotary axis attachment.
6. Set your focus manually, carefully and safely. It is not recommended to use the auto focus with a rotary axis attachment for the simple reason that you are not working with a flat object. Set your origin
7. Generate a graphic with the help of the graphics software. The graphics size must be adjusted until less than the dimensions of the work piece.
8. Select "Output", and then input the diameter of the object and the circle pulse. How to set up the parameter for "enable rotate engrave", please click below link for the instruction
9. Select "Download", click "Origin" and "Frame" on the LCD display, please make sure that the material is in the right location and enough space for working.
10. Finally press the "Start-Pause" button in the LCD display, to start the engraving or cutting process.

## 4.13 For Laser Engraving

The engraving depth can easily be varied through the laser power or the speed. To increase the engraving depth, reduce the speed or increase the power setting. This way you increase the amount of energy per area unit. Engraving too deep, however, reduces the quality of the details. With coated materials the required power depends of the kind and thickness of the coating. With power set too high the individual lines become too thick and a sharp picture cannot be achieved. The resolution of the graphics should usually be at 500 dpi. The dpi setting (number of laser dots per inch) depends on the material. The lower this setting is, the lower the resolution of the engraved picture will be. This, however, reduces flaming and increases the energy of a pulse, which can improve the overall result (e.g. when engraving some sorts of plastic materials).

### 1. Plastics

Plastics for engraving are available in many different colors and thicknesses and with many different coatings and surfaces. The majority of available plastics can be well engraved and cut with the laser. Plastics with a micro-porous surface seem to give the best result, because less surface material needs to be removed. As most plastic materials have a low melting point, a low pip setting should be selected to reduce the danger of melting.

### 2. Acrylic

There are two different types of acrylic – cast and extruded. The cast acrylic becomes white or mat after engraving, the extruded acrylic remains clear. Use extruded acrylic for engravings that are filled with paint and cast acrylic for normal engravings. Cast acrylic can be best engraved without protection foil. It is better to engrave the entire surface with a low energy setting.

### 3. Engrave the rubber stamp

The various mixtures and densities of rubber plates cause a slightly varying engraving depth. The settings in the overview table give a good indication. Since engraving a standard rubber material requires a relatively high laser power, the laser power is principally set to 40% or more high and only the speed is varied. Due to their lower density, so-called micro porous rubber materials allow a significantly higher engraving speed. Test the rubber first, to find out the correct speed setting.

The RDWorksV8 software using the engraving function, you can choose “Ramp Effect” or common engraving, once you choose “Ramp Effect” and you will need to set a minimum power lower than Max Power, generally we set it to about 15%, and input a value with the Ramp Length what you want, but if you want to make it better, you may need to test different kinds of power and speed by yourself, then you can get the best result.

Engraving rubber produces a considerable amount of dust and terrible gas. Therefore a well-dimensioned exhaust system and its regular maintenance are very important.

## Chapter 5. Maintenance

### 5.1 Cleaning the Laser Machine



Caution – use of controls or adjustments or performance of procedures other than those specified here in may result in hazardous laser radiation exposure.

Before starting cleaning and maintenance work always switch off the device and unplug the mains plug.

Always keep the system clean, as flammable parts in the working area or exhaust area rise the fire hazard.



You should check at least once a day, whether dust has accumulated in the engraving system.

In case of soiling the machine must be cleaned. The cleaning interval strongly depends on the material that is being processed and the operating time of the device. Please bear in mind that only a clean machine guarantees optimal performance and reduces the service costs.

#### General Cleaning Notes:

1. Make sure, that the device is switched off and unplugged. Open the protective cover.
2. Move the working table into a position in which it is easiest for you to clean the surface with a window cleaning agent and paper towels.
3. Thoroughly remove all loose dirt particles and deposits in the interior of the machine.
4. Clean the cover of the laser tube.
5. You can clean the viewing window with a cotton cloth. Do not use paper towels as they could scratch the acrylic.

## 5.2 Cleaning the Optical Parts

The lens has a durable multi-coating and won't be damaged by correct and careful cleaning. You should inspect the focus lens and the mirrors and the beam combiner according the maintenance plan. If you discover a veil of haze or dirt, you must clean them.

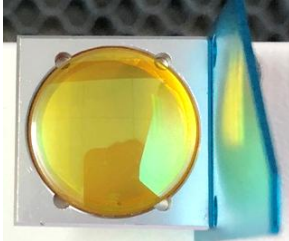

It is suggested to clean the mirrors/lens before work every day in order to run the machine at max efficiency.

**Please turn off the power of laser machine before cleaning the optical parts.**



1. Lens cleaning fluid and cotton swabs are in the tool box that came with the machine.
2. The lens must be cleaned carefully with a clean cotton swab to avoid scratching the surface of the lens.
3. Do not touch the lens with your hands after wiping.
4. Never use a cleaning swab twice.

Follow the instructions below for the cleaning of optical parts:



**5.2.1 Cleaning the Focus Lens**

1. Move the working table to a distance approx. 10 cm under the lens holder.
2. Move the working head into the center of the working surface.
3. Now you can loose the two black screws slightly, then take the lens out.
4. Remove the coarse dust as good as possible by blowing air onto the lens surface.
5. Check the surface and if necessary clean the lens with the lens cleaning liquid and swabs.
6. Put some lens cleaning liquid on one side of the lens. Leave the liquid to take effect for approximately one minute and then gently wipe it away with cleaning swabs soaked with lens cleaning liquid.
7. Finally, dry this side of the lens with dry cleaning swabs and repeat the cleaning process on the other side of the lens. Never use a cleaning swabs twice. Dust accumulated in the cleaning swabs could scratch the lens surface.
8. Examine the lens. If it is still soiled, repeat the cleaning process until the lens is clean.
9. Carefully tight the lens holder.

**How to take out the focus lens, please just as following the picture indicated:**

1. Turn the two screws counterclockwise



2. Pull the focus lens out

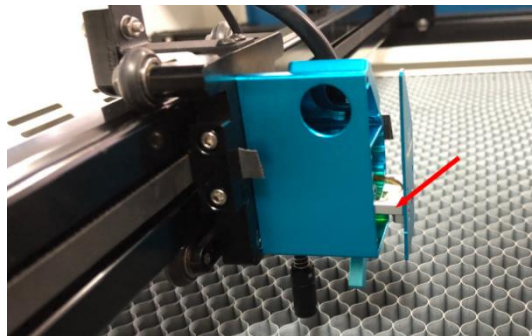

3. Clean concave side of lens with swabs

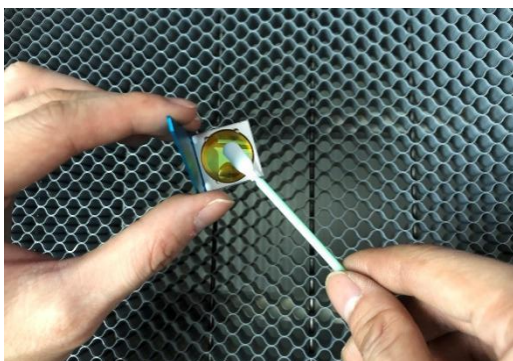

4. Clean convex side of lens with swabs

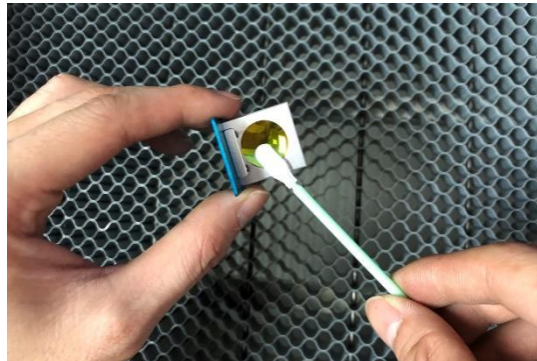



### 5.2.2 Cleaning the Mirrors

There are three mirrors in the operating area of the laser, which may have to be cleaned if they are soiled. To clean the reflector, follow the instructions below.

1. Remove the coarse dust as good as possible by blowing air onto the mirror surface.
2. Check the surface and if necessary clean the mirror with the mirror cleaning liquid and swabs.
3. Put some lens cleaning liquid on one side of the mirror. Leave the liquid to take effect for approximately one minute and then gently wipe it away with cleaning swabs soaked with lens cleaning liquid.
4. Finally, dry this side of the mirror with dry cleaning swabs and repeat the cleaning process on the other side of the mirror. Never use a cleaning swabs twice. Dust accumulated in the cleaning swabs could scratch the mirror surface.
5. Examine the mirror. If it is still soiled, repeat the cleaning process until the lens is clean.

#### The Mirror#1

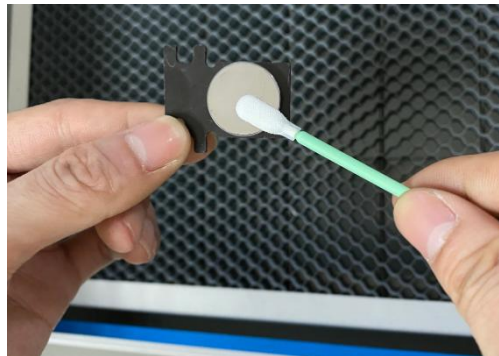
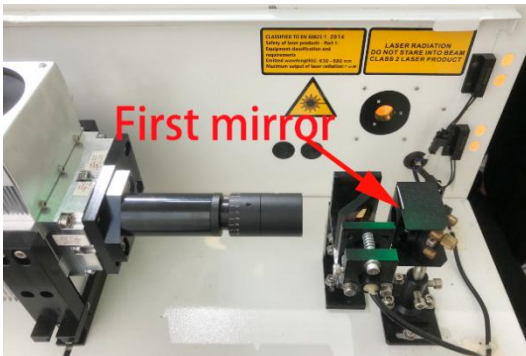

The 1<sup>st</sup> mirror is installed in the rear box of the laser tube, open it then view the right side.

#### The Mirror#2

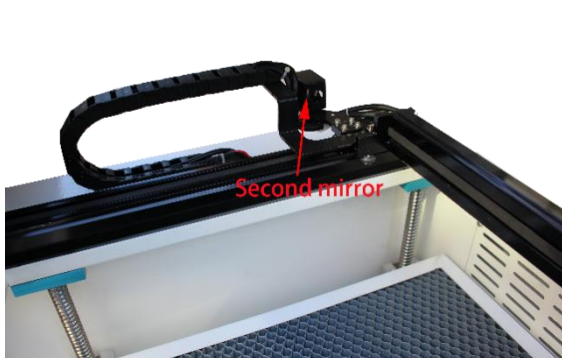

The 2<sup>nd</sup> mirror is installed on the left side of X rail.

**The Mirror#3**

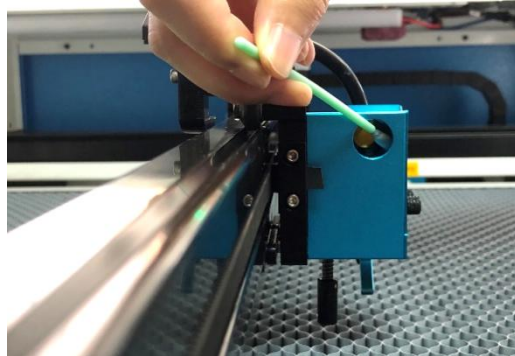
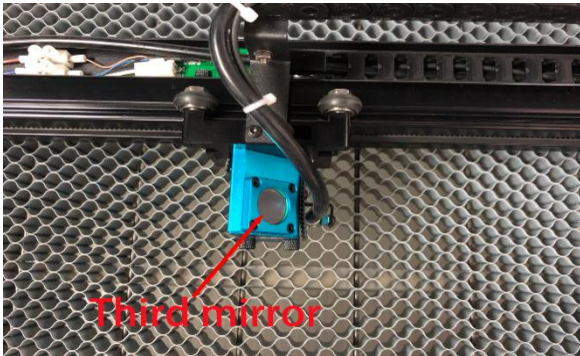

The 3<sup>rd</sup> mirror is installed on the top of the laser head.

**How to take out the mirrors, please just as following below indicated:**

**Mirror 1&2**

1. Unscrew the screw of the mirror

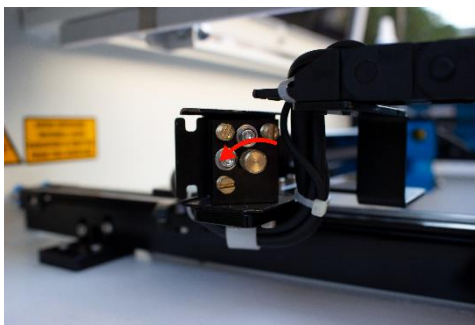

2. Pull the mirror out

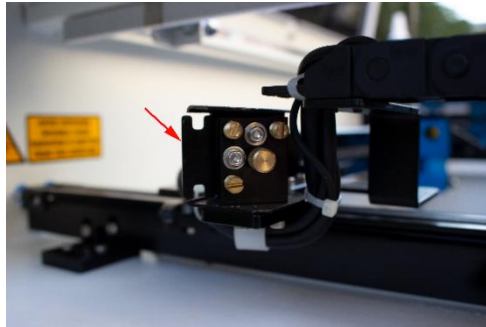

**Mirror 3**

Unscrew the four screws

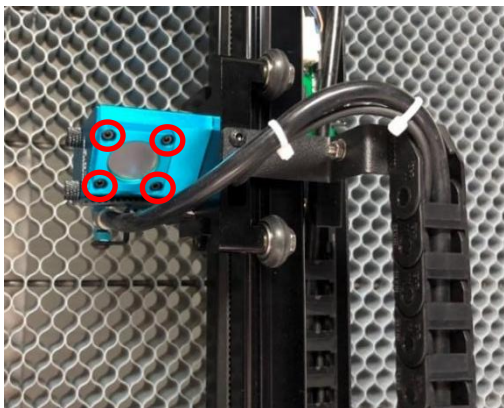

Except for replacement, there is no need to remove the 3rd mirror.

**5.2.3 Cleaning Laser Combiner**

1. The laser combiner is installed on the left side of the first mirror.
2. Remove the coarse dust as good as possible by blowing air onto the combiner surface.
3. Check the surface and if necessary clean the laser combiner with the lens cleaning liquid and swabs.
4. Put some lens cleaning liquid on one side of the swab. Leave the liquid to take effect for approximately one minute and then gently wipe it away with cleaning swabs soaked with lens cleaning liquid.
5. Finally, dry this side of the laser combiner with dry cleaning swabs and repeat the cleaning process on the other side of the lens. Never use a cleaning swab twice. Dust accumulated in the cleaning swabs could scratch the combiner surface.
6. Examine the laser combiner. If it is still soiled, repeat the cleaning process until it is clean.

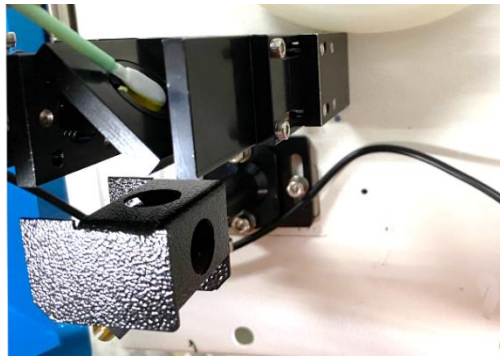



### 5.3 Cleaning the cooling system

For the RF tube, providing a good heat dissipation environment for it determines the stability of its beam output, so it is necessary to regularly clean the dust on the cooling fan of the RF tube and the machine.

It is suggested to use an air blow gun to blow the dust away, as shown in the pictures:

1. Remove the black fan cover and sponge, and use the air blow gun to blow away the dust from the sponge and mesh.



2. Open the tube cover and use the air blow gun to blow away the dust on the fan inside.

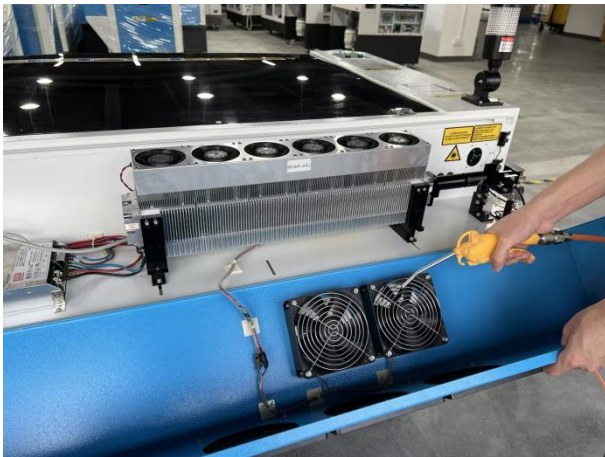

3.Remove the screws which fixed the cooling fan, take out the fan, and use an air blow gun or a pump to blow the dust away.

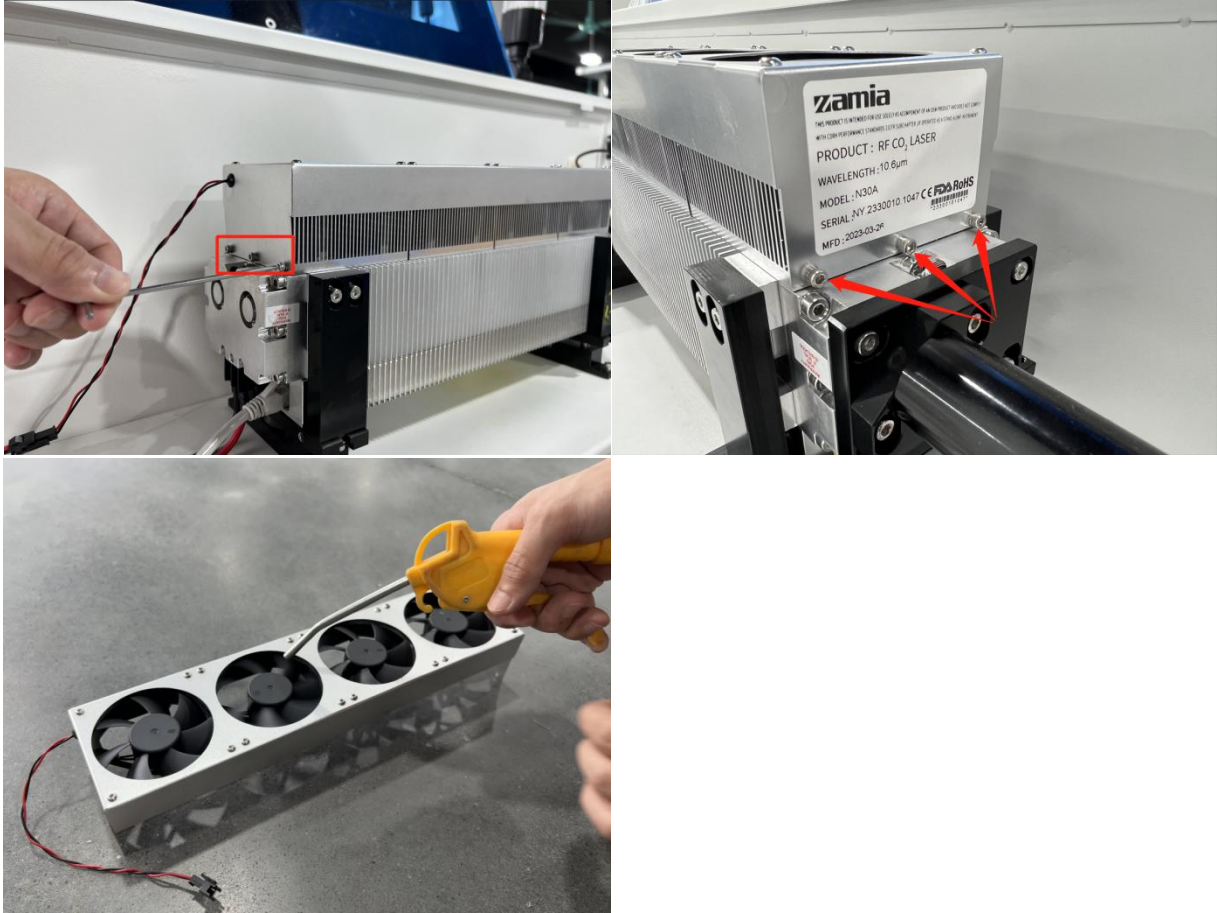

4. Use an air blow gun to blow away the dust on the RF tube, then you can use a rag to wipe the dust around the RF tube.



5. After cleaning the dust, reinstall the fan on the RF tube and the cleaning is finished.

## 5.4 Check the Beam Path

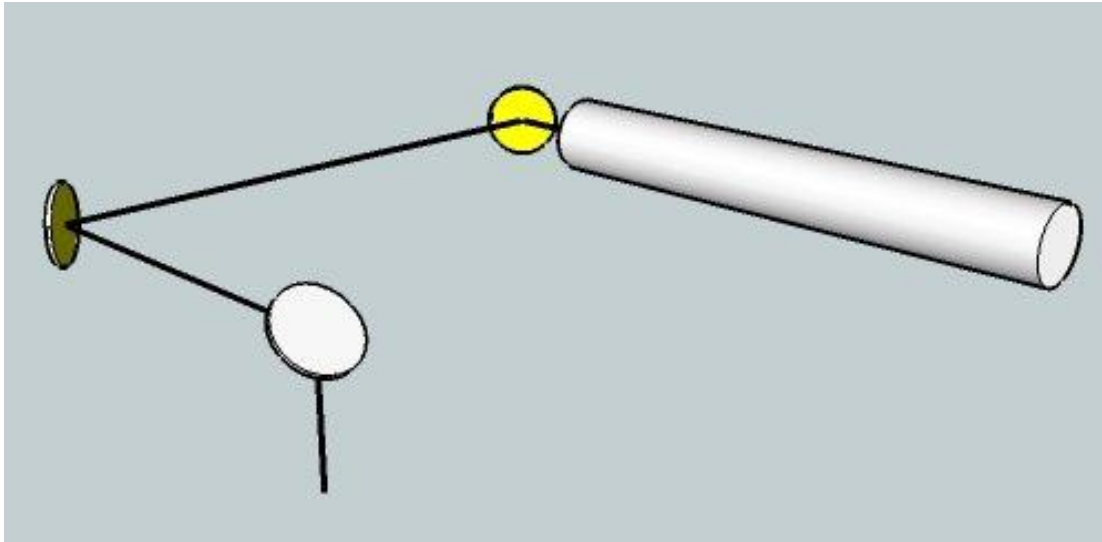

After being used for a long time, the beam path might be deflective. This will reduce the efficient of the laser beam or even cause no laser beam. At this moment, you will need to re-adjust the beam path again.

If you need to know that about adjust the laser beam path of the video on YouTube released by our company and please link to the URL:



## 5.5 Maintain the X/Y/Z Rails

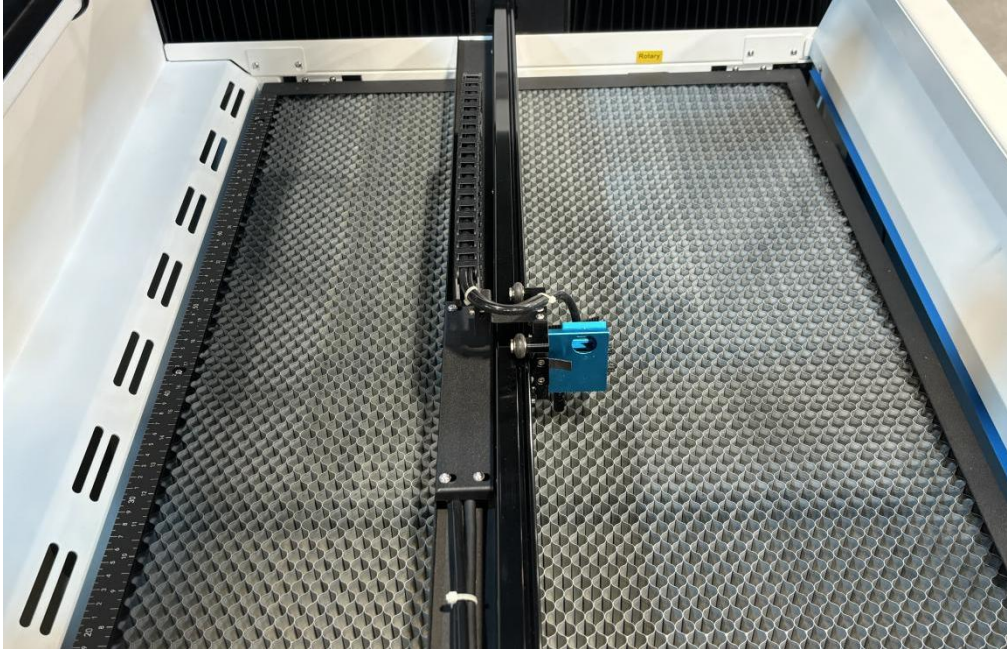

It is suggested to clean the dust on the X/Y rail with alcohol at least every two weeks.



It is suggested to add lubricant oil (or Rust Preventative Grease) to the bars/screws at least every two weeks.

## **5.6 Maintenance Plan**

### **1. DAILY CHECK LIST**

- ① Check Mirrors and lens for condensation and make sure it is clean after work
- ② Check exhaust grille to ensure there is no blockage for exhaust fan
- ③ Check air filter on compressor
- ④ Ensure cooling fans on sides are free from debris
- ⑤ The air blower must be checking and cleaning if required

### **2. WEEKLY CHECK LIST**

- ① Clean debris from under laser bed
- ② Clean rails and lubricate the bar as required
- ③ Clean Acrylic/Tempered glass covers in lid
- ④ The beam combiner must be checking every weekly, and cleaning if required
- ⑤ Clean the exhaust fan to ensure there is no blockage

### **3. MONTHLY CHECK LIST**

- ① Clean the cooling system

**THE END**